

**Řemenice pro upínací pouzdra  
TAPER-LOCK®**

Pro ozubené řemeny

HTD®

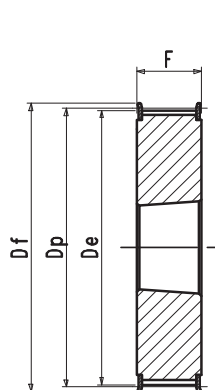

Typ 3F

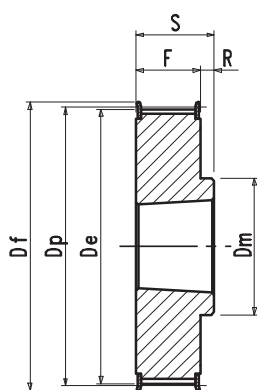

Typ 8F

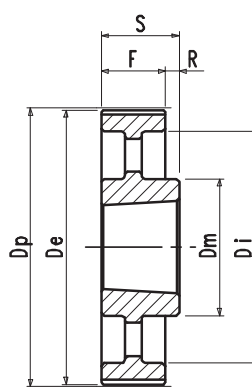

Typ 8A

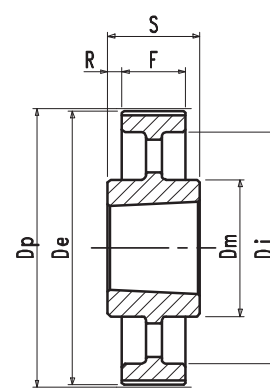

Typ 7A

**HTD® 5M Rozteč 5 mm pro řemeny šířky 15 mm**

Popis	Označení	Obj. č.	Typ	Typ přírub.	Počet zubů	Max ø hřídele	Dp [mm]	De [mm]	Df [mm]	Dm [mm]	Di [mm]	F [mm]	S [mm]	R [mm]	
Ocel	S přírubami	34 5M-15	0515034	3F	F21	1008	25	54,11	52,97	57		22	22		
		36 5M-15	0515036	3F	F22	1108	25	57,30	56,15	60		22	22		
		38 5M-15	0515038	3F	F25	1108	25	60,48	59,34	66		22	22		
		40 5M-15	0515040	3F	F26	1108	25	63,66	62,52	70		22	22		
		44 5M-15	0515044	3F	F27	1108	25	70,03	68,89	75		22	22		
		48 5M-15	0515048	8F	F29	1210	32	76,39	75,25	83	59	22	25	3	
		56 5M-15	0515056	8F	F32	1210	32	89,13	87,39	93	70	22	25	3	
		64 5M-15	0515064	8F	F35	1210	32	101,86	100,72	106	80	22	25	3	
	Bez přírub	72 5M-15	0515072	8A		1610	42	114,59	113,45		92		22	25	3
		80 5M-15	0515080	8A		1610	42	127,32	126,18		92		22	25	3
		90 5M-15	0515090	8A		1610	42	143,24	142,10		92		22	25	3
		112 5M-15	0515112	8A		2012	50	178,25	177,11		110		20	32	12
		136 5M-15	0515136	7A		2012	50	216,45	215,31		110	199	20	32	6

Pro ozubené řemeny

## Řemenice pro upínací pouzdra TAPER-LOCK®

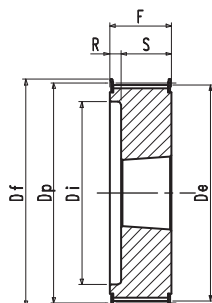

Typ 5F

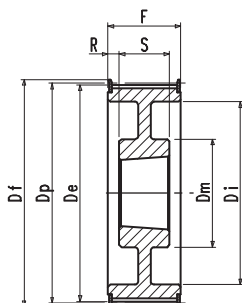

Typ 9WF

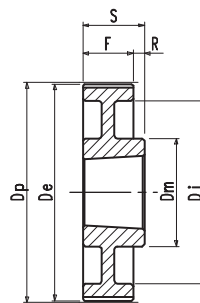

Typ 8W

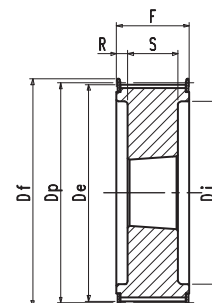

Typ 4F

### HTD® 8M Rozteč 8 mm pro řemeny šířky 20 mm

Popis	Označení	Obj. č.	Typ	Typ přírub.	Počet zubů	Max Ø hřídele	Dp [mm]	De [mm]	Df [mm]	Dm [mm]	Di [mm]	F [mm]	S [mm]	R [mm]	Hmot. [kg]	
Ocel	S přírubami	22 8M-20	0820022	5F	F22	1108	25	56,02	54,65	60		37	28	22	6	0,25
		24 8M-20	0820024	5F	F25	1108	25	61,12	59,75	66		44	28	22	6	0,30
		26 8M-20	0820026	5F	F26	1108	25	66,21	64,84	70		45	28	22	6	0,36
		28 8M-20	0820028	5F	F27	1108	25	71,30	70,08	75		50	28	22	6	0,44
		30 8M-20	0820030	5F	F29	1108	25	76,39	75,13	83		58	28	22	6	0,53
		32 8M-20	0820032	5F	F30	1610	42	81,49	80,16	87		63	28	25	3	0,42
		34 8M-20	0820034	5F	F31	1610	42	86,58	85,22	91		64	28	25	3	0,55
		36 8M-20	0820036	5F	F33	1610	42	91,67	90,30	97		68	28	25	3	0,68
		38 8M-20	0820038	5F	F34	1610	42	96,77	95,39	102		72	28	25	3	0,80
		40 8M-20	0820040	5F	F35	1610	42	101,86	100,49	106		76	28	25	3	1,00
		44 8M-20	0820044	8F	F38	2012	50	112,05	110,67	120	93		28	32	4	1,20
		48 8M-20	0820048	8F	F40	2012	50	122,23	120,86	128	96		28	32	4	1,60
		56 8M-20	0820056	8F	F48	2012	50	142,60	141,23	150	110		28	32	4	2,40
		64 8M-20	0820064	9WF	F52	2012	50	162,97	161,60	168	110	137	28	32	4	2,70
72 8M-20	0820072	9WF	F57	2012	50	183,35	181,97	192	110	158	28	32	4	3,30		
Litina	Bez přírub	80 8M-20	0820080	8W		2012	50	203,72	202,35		110	180	28	32	4	3,50
		90 8M-20	0820090	8A		2012	50	229,18	227,81		110	204	28	32	4	3,65
		144 8M-20	0820144	8A		2517	60	366,69	365,32		125	336	28	32	4	4,80

### HTD® 8M Rozteč 8 mm pro řemeny šířky 30 mm

Popis	Označení	Obj. č.	Typ	Typ přírub.	Počet zubů	Max Ø hřídele	Dp [mm]	De [mm]	Df [mm]	Dm [mm]	Di [mm]	F [mm]	S [mm]	R [mm]	Hmot. [kg]	
Ocel	S přírubami	22 8M-30	0830022	5F	F22	1108	25	56,02	54,65	60		37	38	22	16	0,31
		24 8M-30	0830024	5F	F25	1108	25	61,12	59,75	66		44	38	22	16	0,38
		26 8M-30	0830026	5F	F26	1108	25	66,21	64,84	70		44	38	22	16	0,45
		28 8M-30	0830028	5F	F27	1210	32	71,30	70,08	75		50	38	25	13	0,50
		30 8M-30	0830030	3F	F29	1615	42	76,39	75,13	83			38	38		0,55
		32 8M-30	0830032	3F	F30	1615	42	81,49	80,16	87			38	38		0,59
		34 8M-30	0830034	3F	F31	1615	42	86,58	85,22	91			38	38		0,77
		36 8M-30	0830036	3F	F33	1615	42	91,67	90,30	97			38	38		0,96
		38 8M-30	0830038	3F	F34	1615	42	96,77	95,39	102			38	38		1,15
		40 8M-30	0830040	3F	F35	1615	42	101,86	100,49	106			38	38		1,34
		44 8M-30	0830044	4F	F38	2012	50	112,05	110,67	120		86	38	32	6	1,33
		48 8M-30	0830048	4F	F40	2012	50	122,23	120,86	128		90	38	32	6	1,78
		56 8M-30	0830056	4F	F48	2012	50	142,60	141,23	150		110	38	32	6	3,76
		64 8M-30	0830064	8F	F52	2517	60	162,97	161,60	168	125		38	45	7	4,20
72 8M-30	0830072	9WF	F57	2517	60	183,35	181,97	192	125	158	38	45	7	4,30		
Litina	Bez přírub	80 8M-30	0830080	8W		2517	60	203,72	202,35		125	180	38	45	7	4,60
		90 8M-30	0830090	8A		2517	60	229,18	227,81		125	204	38	45	7	5,00
		112 8M-30	0830112	8A		2517	60	285,21	283,83		125	254	38	45	7	6,20
		144 8M-30	0830144	8A		2517	60	366,69	365,32		125	336	38	45	7	9,00

**Řemenice pro upínací pouzdra  
TAPER-LOCK®**

Pro ozubené řemeny

HTD®

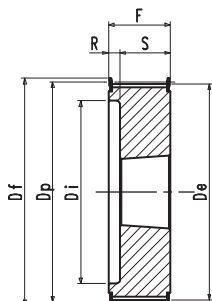

Typ 5F

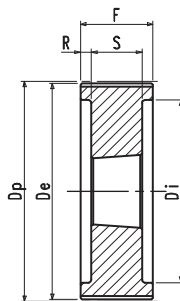

Typ 4

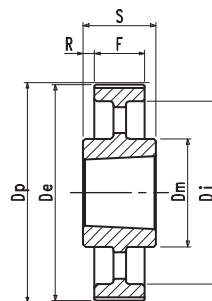

Typ 7A

**HTD® 8M Rozteč 8 mm pro řemeny šířky 50 mm**

Popis	Označení	Obj. č.	Typ	Typ přírub.	Počet zubů	Max Ø hřídele	Dp [mm]	De [mm]	Df [mm]	Dm [mm]	Di [mm]	F [mm]	S [mm]	R [mm]	Hmot. [kg]
Ocel	S přírubami	28 8M-50	4F	F27	1210	32	71,30	70,08	75		50	60	25	17,5	0,60
		30 8M-50	5F	F29	1615	42	76,39	75,13	83		58	60	38	22	0,65
		32 8M-50	5F	F30	1615	42	81,49	80,16	87		62	60	38	22	0,82
		34 8M-50	5F	F31	1615	42	86,58	85,22	91		65	60	38	22	1,06
		36 8M-50	5F	F33	1615	42	91,67	90,30	97		68	60	38	22	1,30
		38 8M-50	5F	F34	1615	42	96,77	95,39	102		72	60	38	22	1,60
		40 8M-50	4F	F35	2012	50	101,86	100,49	106		82	60	32	14	1,71
		44 8M-50	4F	F38	2012	50	112,05	110,67	120		91	60	32	14	1,78
		48 8M-50	4F	F40	2012	50	122,23	120,86	128		95	60	32	14	2,30
		56 8M-50	4F	F48	2517	60	142,60	141,23	150		116	60	45	7,5	3,40
		64 8M-50	4F	F52	2517	60	162,97	161,60	168		137	60	45	7,5	5,00
		72 8M-50	4F	F57	2517	60	183,35	181,97	192		158	60	45	7,5	6,70
Litina	Bez přírub	80 8M-50	4		3020	75	203,72	202,35			180	60	51	4,5	8,80
		90 8M-50	9W		3020	75	229,18	227,81		170	204	60	51	4,5	10,00
		112 8M-50	9W		3020	75	285,21	283,83		170	260	60	51	4,5	12,00
		144 8M-50	9A		3020	75	366,69	365,32		170	341	60	51	2,5	15,20
		168 8M-50	7A		3020	75	427,81	426,44		198	402	60	65	2,5	17,50
		192 8M-50	7A		3020	75	488,92	487,55		198	460	60	65	2,5	24,00

**HTD® 8M Rozteč 8 mm pro řemeny šířky 85 mm**

Popis	Označení	Obj. č.	Typ	Typ přírub.	Počet zubů	Max Ø hřídele	Dp [mm]	De [mm]	Df [mm]	Dm [mm]	Di [mm]	F [mm]	S [mm]	R [mm]	Hmot. [kg]
Ocel	S přírubami	34 8M-85	4F	F31	1615	42	86,58	85,22	91		65	95	38	28,5	1,43
		36 8M-85	4F	F33	1615	42	91,67	90,30	97		68	95	38	28,5	1,87
		38 8M-85	4F	F34	1615	42	96,77	95,39	102		72	95	38	28,5	2,20
		40 8M-85	4F	F35	2012	50	101,86	100,49	106		82	95	32	31,5	1,80
		44 8M-85	4F	F38	2012	50	112,05	110,67	120		91	95	32	31,5	2,30
		48 8M-85	4F	F40	2517	60	122,23	120,86	128		100	95	45	25	2,66
		56 8M-85	4F	F48	2517	60	142,60	141,23	150		117	95	45	25	4,45
		64 8M-85	4F	F52	2517	60	162,97	161,60	168		137	95	45	25	6,20
72 8M-85	4F	F57	3020	75	183,35	181,97	192		158	95	51	22	8,00		
Litina	Bez přírub	80 8M-85	4		3020	75	203,72	202,35			180	95	51	22	10,00
		90 8M-85	9W		3020	75	229,18	227,81		170	204	95	51	22	10,80
		112 8M-85	9W		3020	75	285,21	283,83		170	260	95	51	22	15,00
		144 8M-85	9A		3525	90	366,69	365,32		198	336	95	65	15	20,00
		168 8M-85	9A		3525	90	427,81	426,44		198	395	95	65	15	22,00
		192 8M-85	9A		3525	90	488,92	487,55		198	455	95	65	15	26,00

Pro ozubené řemeny

Řemenice pro upínací pouzdra  
TAPER-LOCK®

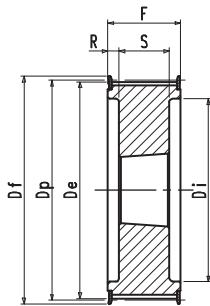

Typ 4F

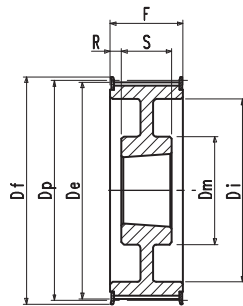

Typ 9WF

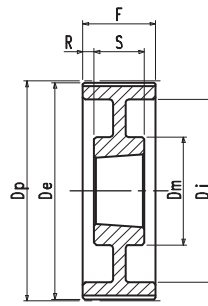

Typ 9W

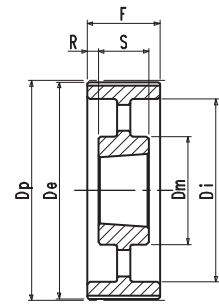

Typ 9A

## HTD® 14M Rozteč 14 mm pro řemeny šířky 40 mm

Popis	Označení	Obj. č.	Typ	Typ přírub.	Počet zubů	Max Ø hřídele	Dp [mm]	De [mm]	Df [mm]	Dm [mm]	Di [mm]	F [mm]	S [mm]	R [mm]	Hmot. [kg]
Ocel	S přírubami	28 14M-40	4F	F40	2012	50	124,78	122,12	128		94	54	32	11	2,07
		29 14M-40	4F	F43	2012	50	129,23	126,57	138		98	54	32	11	2,38
		30 14M-40	4F	F43	2012	50	133,69	130,99	138		98	54	32	11	2,65
		32 14M-40	4F	F49	2012	50	142,60	139,88	154		108	54	32	11	3,40
		34 14M-40	4F	F51	2517	60	151,52	148,79	160		110	54	45	4,5	3,87
		36 14M-40	4F	F52	2517	60	160,43	157,68	168		120	54	45	4,5	4,80
		38 14M-40	4F	F55	2517	60	169,34	166,60	184		130	54	45	4,5	5,40
		40 14M-40	4F	F56	2517	60	178,25	175,49	188		138	54	45	4,5	6,00
		44 14M-40	4F	F61	3020	75	196,08	193,28	212		155	54	51	1,5	7,80
		48 14M-40	4F	F62	3020	75	213,90	211,11	226		170	54	51	1,5	9,40
Litina	Bez přírub	56 14M-40	9WF	F66	3020	75	249,55	246,76	256	170	208	54	51	1,5	10,80
		64 14M-40	9WF	F70	3020	75	285,21	282,41	296	170	240	54	51	1,5	13,40
		72 14M-40	9W		3020	75	320,86	318,06		170	280	54	51	1,5	15,20
		80 14M-40	9A		3020	75	356,51	353,71		170	315	54	51	1,5	16,00
		90 14M-40	9A		3020	75	401,07	398,28		170	360	54	51	1,5	17,80
		112 14M-40	9A		3020	75	499,11	496,32		170	457	54	51	1,5	25,60
		144 14M-40	9A		3020	75	641,71	638,92		170	600	54	51	1,5	32,00
		168 14M-40	9A		3020	75	748,66	745,87		170	706	54	51	1,5	44,00
		192 14M-40	9A		3020	75	855,62	852,82		170	813	54	51	1,5	49,00
		216 14M-40	9A		3020	75	962,57	959,76		170	920	54	51	1,5	55,00

### Řemenice pro upínací pouzdra TAPER-LOCK®

Pro ozubené řemeny

HTD®

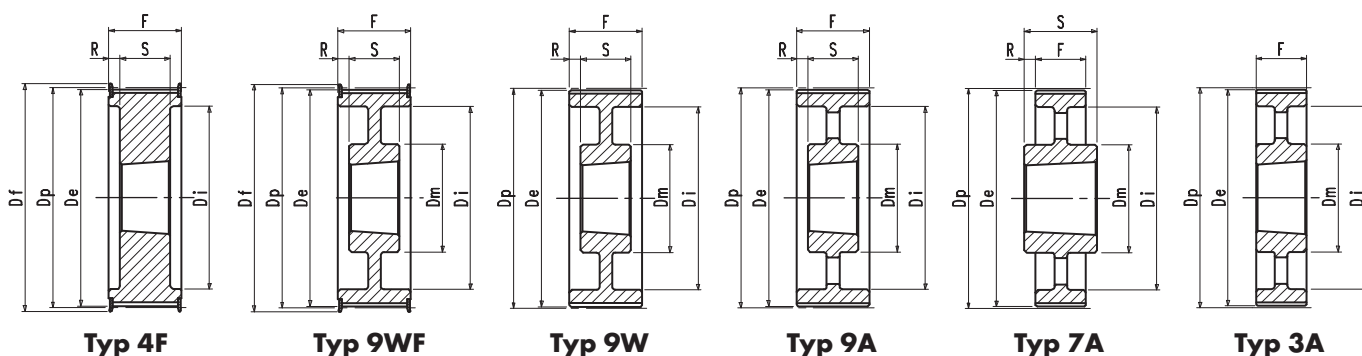

### HTD® 14M Rozteč 14 mm pro řemeny šířky 55 mm

Popis	Označení	Obj. č.	Typ	Typ přírub.	Počet zubů	Max ø hřídele	Dp [mm]	De [mm]	Df [mm]	Dm [mm]	Di [mm]	F [mm]	S [mm]	R [mm]	Hmot. [kg]
Ocel	S přírubami	28 14M-55	4F	F40	2012	50	124,78	122,12	128		94	70	32	19	2,20
		29 14M-55	4F	F43	2012	50	129,23	126,57	138		100	70	32	19	2,74
		30 14M-55	4F	F43	2517	60	133,69	130,99	138		100	70	45	12,5	2,70
		32 14M-55	4F	F49	2517	60	142,60	139,88	154		108	70	45	12,5	3,66
		34 14M-55	4F	F51	2517	60	151,52	148,79	160		110	70	45	12,5	4,55
		36 14M-55	4F	F52	2517	60	160,43	157,68	168		120	70	45	12,5	5,20
		38 14M-55	4F	F55	2517	60	169,34	166,60	184		130	70	45	12,5	6,20
		40 14M-55	4F	F56	2517	60	178,25	175,49	188		138	70	45	12,5	7,00
		44 14M-55	4F	F61	3020	75	196,08	193,28	212		155	70	51	9,5	8,60
		48 14M-55	4F	F62	3020	75	213,90	211,11	226		170	70	51	9,5	10,40
Litina	Bez přírub	56 14M-55	9WF	F66	3020	75	249,55	246,76	256	170	208	70	51	9,5	12,40
		64 14M-55	9WF	F70	3020	75	285,21	282,41	296	170	240	70	51	9,5	14,50
		72 14M-55	9W		3020	75	320,86	318,06		170	280	70	51	9,5	16,20
		80 14M-55	9A		3020	75	356,51	353,71		170	315	70	51	9,5	17,50
		90 14M-55	9A		3020	75	401,07	398,28		170	360	70	51	9,5	20,10
		112 14M-55	9A		3020	75	499,11	496,32		170	457	70	51	9,5	28,40
		144 14M-55	9A		3020	75	641,71	638,92		170	600	70	51	9,5	36,20
		168 14M-55	9A		3020	75	748,66	745,87		170	706	70	51	9,5	49,00
		192 14M-55	9A		3020	75	855,62	852,82		170	813	70	51	9,5	53,00
		216 14M-55	7A		3535	90	962,57	959,76		190	920	70	89	9,5	65,80

### HTD® 14M Rozteč 14 mm pro řemeny šířky 85 mm

Popis	Označení	Obj. č.	Typ	Typ přírub.	Počet zubů	Max ø hřídele	Dp [mm]	De [mm]	Df [mm]	Dm [mm]	Di [mm]	F [mm]	S [mm]	R [mm]	Hmot. [kg]
Ocel	S přírubami	28 14M-85	4F	F40	2517	60	124,78	122,12	128		98	102	45	28,5	2,70
		29 14M-85	4F	F43	2517	60	129,23	126,57	138		100	102	45	28,5	3,40
		30 14M-85	4F	F43	2517	60	133,69	130,99	138		100	102	45	28,5	3,75
		32 14M-85	4F	F49	2517	60	142,60	139,88	154		108	102	45	28,5	4,80
		34 14M-85	4F	F51	2517	60	151,52	148,79	160		110	102	45	28,5	6,00
		36 14M-85	4F	F52	3020	75	160,43	157,68	168		120	102	51	25,5	5,80
		38 14M-85	4F	F55	3020	75	169,34	166,60	184		130	102	51	25,5	6,80
		40 14M-85	4F	F56	3020	75	178,25	175,49	188		138	102	51	25,5	8,00
		44 14M-85	4F	F61	3020	75	196,08	193,28	212		153	102	51	25,5	11,80
		48 14M-85	4F	F62	3020	75	213,90	211,11	226		170	102	51	25,5	15,10
Litina	Bez přírub	56 14M-85	9WF	F66	3525	90	249,55	246,76	256	190	210	102	65	18,5	19,00
		64 14M-85	9WF	F70	3525	90	285,21	282,41	296	190	240	102	65	18,5	23,00
		72 14M-85	9W		3525	90	320,86	318,06		190	280	102	65	18,5	25,00
		80 14M-85	9A		3525	90	356,51	353,71		190	315	102	65	18,5	26,00
		90 14M-85	9A		3525	90	401,07	398,28		190	360	102	65	18,5	27,80
		112 14M-85	9A		3525	90	499,11	496,32		190	457	102	65	18,5	36,50
		144 14M-85	9A		3525	90	641,71	638,92		190	600	102	65	18,5	48,00
		168 14M-85	9A		3525	90	748,66	745,87		190	706	102	65	18,5	60,00
		192 14M-85	3A		4040	100	855,62	852,82		190	813	102	102		86,00
		216 14M-85	3A		4040	100	962,57	959,76		190	920	102	102		91,50

Pro ozubené řemeny

## Řemenice pro upínací pouzdra TAPER-LOCK®

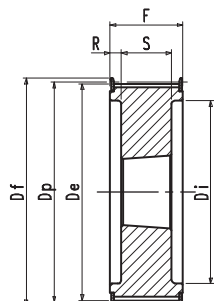

Typ 4F

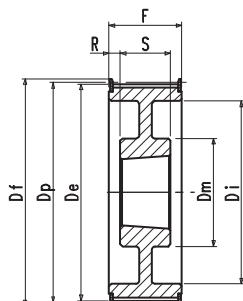

Typ 9WF

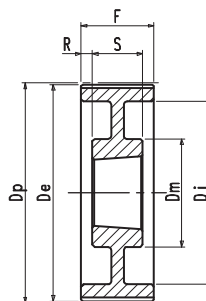

Typ 9W

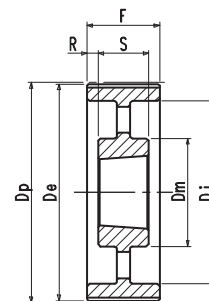

Typ 9A

### HTD® 14M Rozteč 14 mm pro řemeny šířky 115 mm

Popis	Označení	Obj. č.	Typ	Typ přírub.	Počet zubů	Max ø hřídele	Dp [mm]	De [mm]	Df [mm]	Dm [mm]	Di [mm]	F [mm]	S [mm]	R [mm]	Hmot. [kg]
Ocel	S přírubami	28 14M-115	4F	F40	2517	60	124,78	122,12	128		98	133	45	44	3,77
		29 14M-115	4F	F43	2517	60	129,23	126,57	138		100	133	45	44	4,00
		30 14M-115	4F	F43	2517	60	133,69	130,99	138		100	133	45	44	5,00
		32 14M-115	4F	F49	2517	60	142,60	139,88	154		108	133	45	44	6,80
		34 14M-115	4F	F51	2517	60	151,52	148,79	160		110	133	45	44	6,80
		36 14M-115	4F	F52	3020	75	160,43	157,68	168		125	133	51	41	7,00
		38 14M-115	4F	F55	3020	75	169,34	166,60	184		130	133	51	41	8,40
		40 14M-115	4F	F56	3020	75	178,25	175,49	188		138	133	51	41	9,20
		44 14M-115	4F	F61	3030	75	196,08	193,28	212		155	133	76	28,5	14,00
		48 14M-115	4F	F62	3030	75	213,90	211,11	226		170	133	76	28,5	17,10
Litina	Bez přírub	56 14M-115	4F	F66	3535	90	249,55	246,76	256		208	133	89	22	24,80
		64 14M-115	4F	F70	3535	90	285,21	282,41	296	190	240	133	89	22	27,00
		72 14M-115	9WF	F70	3535	90	320,86	318,06		190	280	133	89	22	29,00
		80 14M-115	9A		3535	90	356,51	353,71		190	315	133	89	22	32,00
		90 14M-115	9A		3535	90	401,07	398,28		190	360	133	89	22	36,50
		112 14M-115	9A		3535	90	499,11	496,32		190	457	133	89	22	46,00
		144 14M-115	9A		4040	100	641,71	638,92		230	600	133	102	15,5	68,00
		168 14M-115	9A		4040	100	748,66	745,87		230	706	133	102	15,5	82,60
		192 14M-115	9A		4040	100	855,62	852,82		230	813	133	102	15,5	96,00
		216 14M-115	9A		4040	100	962,57	959,76		230	920	133	102	15,5	107,00

### HTD® 14M Rozteč 14 mm pro řemeny šířky 170 mm

Popis	Označení	Obj. č.	Typ	Typ přírub.	Počet zubů	Max ø hřídele	Dp [mm]	De [mm]	Df [mm]	Dm [mm]	Di [mm]	F [mm]	S [mm]	R [mm]	Hmot. [kg]
Ocel	S přírubami	38 14M-170	4F	F55	3030	75	169,34	166,60	184		130	187	76	55,5	11,70
		40 14M-170	4F	F56	3030	75	178,25	175,49	188		138	187	76	55,5	13,00
		44 14M-170	4F	F61	3535	90	196,08	193,28	212		153	187	89	49	15,00
		48 14M-170	4F	F62	3535	90	213,90	211,11	226		170	187	89	49	19,00
		56 14M-170	4F	F66	3535	90	249,55	246,76	256		208	187	89	49	28,50
		64 14M-170	4F	F70	4040	100	285,21	282,41	296		240	187	102	42,5	41,00
Litina	Bez přírub	72 14M-170	9W		4040	100	320,86	318,06		230	280	187	102	42,5	46,90
		80 14M-170	9W		4040	100	356,51	353,71		230	315	187	102	42,5	48,00
		90 14M-170	9A		4040	100	401,07	398,28		230	360	187	102	42,5	52,50
		112 14M-170	9A		5050	125	499,11	496,32		265	457	187	127	30	74,50
		144 14M-170	9A		5050	125	641,71	638,92		265	600	187	127	30	91,00
		168 14M-170	9A		5050	125	748,66	745,87		265	706	187	127	30	116,00
		192 14M-170	9A		5050	125	855,62	852,82		265	813	187	127	30	134,00
		216 14M-170	9A		5050	125	962,57	959,76		265	920	187	127	30	146,50