

Řemenice pro řemeny T 2,5

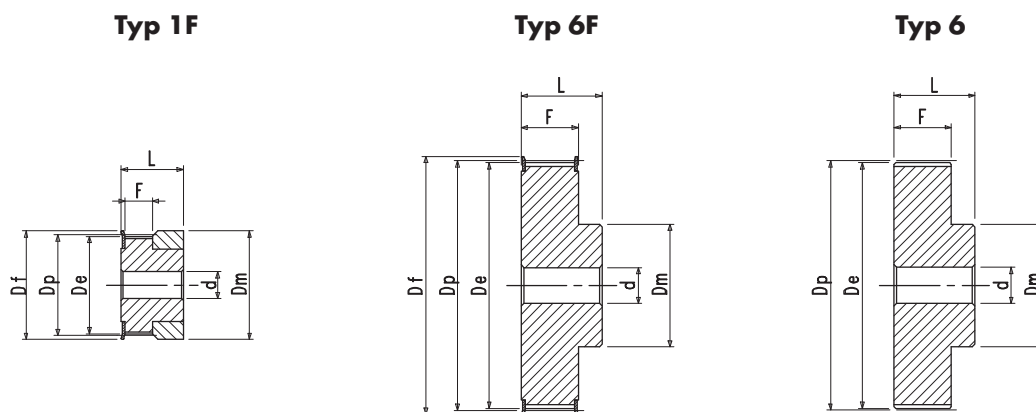

Objednací kód – příklad

40T 10/32-2

40 – Celková šířka řemenice (L)

T 10 – Rozteč – 10 mm

30 – Počet zubů řemenice

2 – Počet přírub na řemenici

Materiál

Hliník 6082 T6 UNI 9006/4

T 2,5 Rozteč 2,5 mm pro řemeny šířky 6 mm

Označení	Obj. č.	Typ	Typ příruby	Počet zubů	Dp [mm]	De [mm]	Df [mm]	Dm [mm]	F [mm]	L [mm]	d [mm]	Hmot. [kg]
16T2,5/12-2	16T2012	1F	F01	12	9,60	9,00	13,0	13	9	16	4	0,004
16T2,5/14-2	16T2014	1F	F02	14	11,20	10,60	15,0	15	9	16	4	0,006
16T2,5/15-2	16T2015	1F	F02	15	12,00	11,40	15,0	15	9	16	4	0,006
16T2,5/16-2	16T2016	1F	F03	16	12,80	12,20	16,0	16	9	16	4	0,006
16T2,5/18-2	16T2018	6F	F04	18	14,40	13,80	17,5	10	10	16	4	0,006
16T2,5/19-2	16T2019	6F	F05	19	15,20	14,60	18,0	10	10	16	4	0,007
16T2,5/20-2	16T2020	6F	F06	20	16,00	15,40	20,0	11	10	16	4	0,008
16T2,5/22-2	16T2022	6F	F07	22	16,60	17,00	23,0	11	10	16	4	0,010
16T2,5/24-2	16T2024	6F	F07	24	19,15	18,55	23,0	12	10	16	4	0,012
16T2,5/25-2	16T2025	6F	F07	25	19,95	19,35	23,0	13	10	16	4	0,013
16T2,5/26-2	16T2026	6F	F09	26	20,75	20,15	25,0	14	10	16	4	0,015
16T2,5/28-2	16T2028	6F	F09	28	22,35	21,75	25,0	14	10	16	4	0,016
16T2,5/30-2	16T2030	6F	F09	30	23,95	23,35	28,0	16	10	16	6	0,018
16T2,5/32-2	16T2032	6F	F10	32	25,95	24,95	32,0	16	10	16	6	0,020
16T2,5/36-2	16T2036	6F	F12	36	28,75	28,10	36,0	20	10	16	6	0,026
16T2,5/40-2	16T2040	6F	F14	40	31,90	31,30	38,0	22	10	16	6	0,032
16T2,5/44-0	16T2044	6F	F15	44	35,10	34,50	42,0	24	10	16	6	0,038
16T2,5/48-0	16T2048	6		48	38,30	37,70		26	10	16	6	0,048
16T2,5/60-0	16T2060	6		60	47,85	47,25		34	10	16	8	0,073

Řemenice s počty zubů neuvedenými v tabulce – na dotaz.

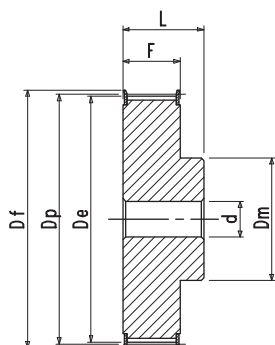
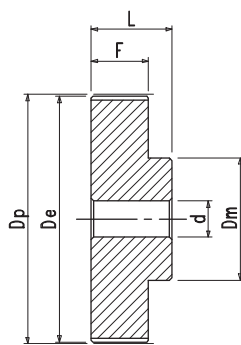
Typ 6F

Typ 6

Řemenice pro řemeny T 5

Materiál: hliník 6082 T6 UNI 9006/4

T 5 Rozteč 5 mm pro řemeny šířky 10 mm

Označení	Obj. č.	Typ	Typ příruby	Počet zubů	Dp [mm]	De [mm]	Df [mm]	Dm [mm]	F [mm]	L [mm]	d [mm]	Hmot. [kg]
21T5/10-2	21T5010	6F	F06	10	16,05	15,05	20,0	8	15	21	4	0,012
21T5/12-2	21T5012	6F	F07	12	19,25	18,25	23,0	11	15	21	4	0,016
21T5/14-2	21T5014	6F	F08	14	22,45	21,45	25,0	13	15	21	4	0,019
21T5/15-2	21T5015	6F	F09	15	24,05	23,05	28,0	16	15	21	6	0,021
21T5/16-2	21T5016	6F	F10	16	25,06	24,60	32,0	18	15	21	6	0,025
21T5/18-2	21T5018	6F	F10	18	28,80	27,80	32,0	20	15	21	6	0,031
21T5/19-2	21T5019	6F	F12	19	30,40	29,40	36,0	22	15	21	6	0,036
21T5/20-2	21T5020	6F	F12	20	32,00	31,00	36,0	23	15	21	6	0,038
21T5/22-2	21T5022	6F	F14	22	35,15	34,15	38,0	24	15	21	6	0,054
21T5/24-2	21T5024	6F	F15	24	38,40	37,40	42,0	26	15	21	6	0,056
21T5/25-2	21T5025	6F	F17	25	39,95	38,95	44,0	26	15	21	6	0,058
21T5/26-2	21T5026	6F	F17	26	41,60	40,60	44,0	26	15	21	6	0,064
21T5/27-2	21T5027	6F	F18	27	43,20	42,20	48,0	30	15	21	8	0,070
21T5/28-2	21T5028	6F	F18	28	44,75	43,75	48,0	32	15	21	8	0,075
21T5/30-2	21T5030	6F	F19	30	47,95	46,95	51,0	34	15	21	8	0,081
21T5/32-2	21T5032	6F	F20	32	51,10	50,10	54,0	38	15	21	8	0,088
21T5/36-2	21T5036	6F	F24	36	57,45	56,45	64,0	38	15	21	8	0,114
21T5/40-2	21T5040	6F	F25	40	63,85	62,85	66,0	40	15	21	8	0,138
21T5/42-2	21T5042	6F	F26	42	67,00	66,00	70,0	40	15	21	8	0,165
21T5/44-0	21T5044	6		44	70,20	69,20		45	15	21	8	0,200
21T5/48-0	21T5048	6		48	76,55	75,55		50	15	21	8	0,307
21T5/60-0	21T5060	6		60	95,65	94,65		65	15	21	8	0,180

T 5 Rozteč 5 mm pro řemeny šířky 16 mm

Označení	Obj. č.	Typ	Typ příruby	Počet zubů	Dp [mm]	De [mm]	Df [mm]	Dm [mm]	F [mm]	L [mm]	d [mm]	Hmot. [kg]
27T5/10-2	27T5010	6F	F06	10	16,05	15,05	20,0	8	21	27	4	0,016
27T5/12-2	27T5012	6F	F07	12	19,25	18,25	23,0	11	21	27	4	0,022
27T5/14-2	27T5014	6F	F08	14	22,45	21,45	25,0	13	21	27	4	0,026
27T5/15-2	27T5015	6F	F09	15	24,05	23,05	28,0	16	21	27	6	0,029
27T5/16-2	27T5016	6F	F10	16	25,06	24,60	32,0	18	21	27	6	0,035
27T5/18-2	27T5018	6F	F10	18	28,80	27,80	32,0	20	21	27	6	0,043
27T5/19-2	27T5019	6F	F12	19	30,40	29,40	36,0	22	21	27	6	0,049
27T5/20-2	27T5020	6F	F12	20	32,00	31,00	36,0	23	21	27	6	0,053
27T5/22-2	27T5022	6F	F14	22	35,15	34,15	38,0	24	21	27	6	0,062
27T5/24-2	27T5024	6F	F15	24	38,40	37,40	42,0	26	21	27	6	0,076
27T5/25-2	27T5025	6F	F17	25	39,95	38,95	44,0	26	21	27	6	0,081
27T5/26-2	27T5026	6F	F17	26	41,60	40,60	44,0	26	21	27	6	0,085
27T5/27-2	27T5027	6F	F18	27	43,20	42,20	48,0	30	21	27	8	0,090
27T5/28-2	27T5028	6F	F18	28	44,75	43,75	48,0	32	21	27	8	0,095
27T5/30-2	27T5030	6F	F19	30	47,95	46,95	51,0	34	21	27	8	0,105
27T5/32-2	27T5032	6F	F20	32	51,10	50,10	54,0	38	21	27	8	0,123
27T5/36-2	27T5036	6F	F24	36	57,45	56,45	64,0	38	21	27	8	0,160
27T5/40-2	27T5040	6F	F25	40	63,85	62,85	66,0	40	21	27	8	0,193
27T5/42-2	27T5042	6F	F26	42	67,00	66,00	70,0	40	21	27	8	0,245
27T5/44-0	27T5044	6		44	70,20	69,20		45	21	27	8	0,280
27T5/48-0	27T5048	6		48	76,55	75,55		50	21	27	8	0,430
27T5/60-0	27T5060	6		60	95,65	94,65		65	21	27	8	0,108

Řemenice pro řemeny T 5, T 10

Materiál: hliník 6082 T6 UNI 9006/4

Typ 6F

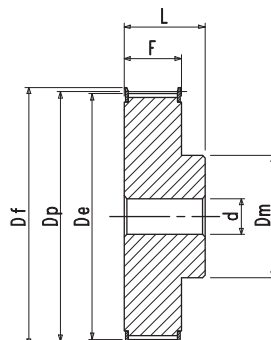

Typ 6

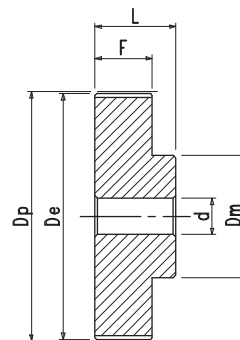

T 5 Rozteč 5 mm pro řemeny šířky 25 mm

Označení	Obj. č.	Typ	Typ příruby	Počet zubů	Dp [mm]	De [mm]	Df [mm]	Dm [mm]	F [mm]	L [mm]	d [mm]	Hmot. [kg]
36T5/10-2	36T5010	6F	F06	10	16,05	15,05	20,0	8	30	36	4	0,023
36T5/12-2	36T5012	6F	F07	12	19,25	18,25	23,0	11	30	36	4	0,031
36T5/14-2	36T5014	6F	F08	14	22,45	21,45	25,0	13	30	36	4	0,037
36T5/15-2	36T5015	6F	F09	15	24,05	23,05	28,0	16	30	36	6	0,041
36T5/16-2	36T5016	6F	F10	16	25,06	24,60	32,0	18	30	36	6	0,050
36T5/18-2	36T5018	6F	F10	18	28,80	27,80	32,0	20	30	36	6	0,061
36T5/19-2	36T5019	6F	F12	19	30,40	29,40	36,0	22	30	36	6	0,070
36T5/20-2	36T5020	6F	F12	20	32,00	31,00	36,0	23	30	36	6	0,076
36T5/22-2	36T5022	6F	F14	22	35,15	34,15	38,0	24	30	36	6	0,092
36T5/24-2	36T5024	6F	F15	24	38,40	37,40	42,0	26	30	36	8	0,109
36T5/25-2	36T5025	6F	F17	25	39,95	38,95	44,0	26	30	36	8	0,116
36T5/26-2	36T5026	6F	F17	26	41,60	40,60	44,0	26	30	36	8	0,121
36T5/27-2	36T5027	6F	F18	27	43,20	42,20	48,0	30	30	36	8	0,128
36T5/28-2	36T5028	6F	F18	28	44,75	43,75	48,0	32	30	36	8	0,142
36T5/30-2	36T5030	6F	F19	30	47,95	46,95	51,0	34	30	36	8	0,150
36T5/32-2	36T5032	6F	F20	32	51,10	50,10	54,0	38	30	36	8	0,176
36T5/36-2	36T5036	6F	F24	36	57,45	56,45	64,0	38	30	36	8	0,230
36T5/40-2	36T5040	6F	F25	40	63,85	62,85	66,0	40	30	36	8	0,276
36T5/42-2	36T5042	6F	F26	42	67,00	66,00	70,0	40	30	36	8	0,352
36T5/44-0	36T5044	6		44	70,20	69,20		45	30	36	8	0,400
36T5/48-0	36T5048	6		48	76,55	75,55		50	30	36	8	0,614
36T5/60-0	36T5060	6		60	95,65	94,65		65	30	36	8	0,180

T 10 Rozteč 10 mm pro řemeny šířky 16 mm

Označení	Obj. č.	Typ	Typ příruby	Počet zubů	Dp [mm]	De [mm]	Df [mm]	Dm [mm]	F [mm]	L [mm]	d [mm]	Hmot. [kg]
31T10/12-2	31T1012	6F	F15	12	38,35	36,35	42	28	21	31	6	0,076
31T10/14-2	31T1014	6F	F18	14	44,70	42,70	48	32	21	31	8	0,104
31T10/15-2	31T1015	6F	F19	15	47,90	45,90	51	32	21	31	8	0,116
31T10/16-2	31T1016	6F	F20	16	51,10	49,10	54	35	21	31	8	0,134
31T10/18-2	31T1018	6F	F22	18	57,45	55,45	60	40	21	31	8	0,167
31T10/19-2	31T1019	6F	F25	19	60,65	58,65	66	44	21	31	8	0,184
31T10/20-2	31T1020	6F	F25	20	63,80	61,80	66	46	21	31	8	0,208
31T10/22-2	31T1022	6F	F27	22	70,20	68,20	75	52	21	31	8	0,240
31T10/24-2	31T1024	6F	F29	24	76,55	74,55	83	58	21	31	8	0,288
31T10/25-2	31T1025	6F	F29	25	79,75	77,75	83	60	21	31	8	0,295
31T10/26-2	31T1026	6F	F30	26	82,90	80,90	87	60	21	31	8	0,310
31T10/27-2	31T1027	6F	F31	27	86,10	84,10	91	60	21	31	8	0,364
31T10/28-2	31T1028	6F	F32	28	89,25	87,25	93	60	21	31	8	0,441
31T10/30-2	31T1030	6F	F33	30	95,65	93,65	97	60	21	31	8	0,493
31T10/32-2	31T1032	6F	F35	32	102,00	100,00	106	65	21	31	10	0,623
31T10/36-2	31T1036	6F	F38	36	114,75	112,75	120	70	21	31	10	0,767
31T10/40-2	31T1040	6F	F41	40	127,45	125,45	131	80	21	31	10	0,950
31T10/44-0	31T1044	6		44	140,20	138,20		88	21	31	10	1,090
31T10/48-0	31T1048	6		48	152,95	150,95		95	21	31	16	1,704
31T10/60-0	31T1060	6		60	191,15	189,10		110	21	31	16	1,704

Řemenice pro řemeny T 10

T 10 Rozteč 10 mm pro řemeny šířky 25 mm

Označení	Obj. č.	Typ	Typ příruby	Počet zubů	Dp [mm]	De [mm]	Df [mm]	Dm [mm]	F [mm]	L [mm]	d [mm]	Hmot. [kg]
40T10/12-2	40T1012	6F	F15	12	38,35	36,35	42	28	30	40	6	0,099
40T10/14-2	40T1014	6F	F18	14	44,70	42,70	48	32	30	40	8	0,134
40T10/15-2	40T1015	6F	F19	15	47,90	45,90	51	32	30	40	8	0,152
40T10/16-2	40T1016	6F	F20	16	51,10	49,10	54	35	30	40	8	0,176
40T10/18-2	40T1018	6F	F22	18	57,45	55,45	60	40	30	40	8	0,224
40T10/19-2	40T1019	6F	F25	19	60,65	58,65	66	44	30	40	8	0,247
40T10/20-2	40T1020	6F	F25	20	63,80	61,80	66	46	30	40	8	0,276
40T10/22-2	40T1022	6F	F27	22	70,20	68,20	75	52	30	40	8	0,310
40T10/24-2	40T1024	6F	F29	24	76,55	74,55	83	58	30	40	8	0,392
40T10/25-2	40T1025	6F	F29	25	79,75	77,75	83	60	30	40	8	0,422
40T10/26-2	40T1026	6F	F30	26	82,90	80,90	87	60	30	40	8	0,480
40T10/27-2	40T1027	6F	F31	27	86,10	84,10	91	60	30	40	8	0,536
40T10/28-2	40T1028	6F	F32	28	89,25	87,25	93	60	30	40	8	0,590
40T10/30-2	40T1030	6F	F33	30	95,65	93,65	97	60	30	40	8	0,640
40T10/32-2	40T1032	6F	F35	32	102,00	100,00	106	65	30	40	10	0,693
40T10/36-2	40T1036	6F	F38	36	114,75	112,75	120	70	30	40	10	0,873
40T10/40-2	40T1040	6F	F41	40	127,45	125,45	131	80	30	40	10	1,067
40T10/44-0	40T1044	6		44	140,20	138,20		88	30	40	10	1,310
40T10/48-0	40T1048	6		48	152,95	150,95		95	30	40	16	1,516
40T10/60-0	40T1060	6		60	191,15	189,10		110	30	40	16	2,339

T 10 Rozteč 10 mm pro řemeny šířky 32 mm

Označení	Obj. č.	Typ	Typ příruby	Počet zubů	Dp [mm]	De [mm]	Df [mm]	Dm [mm]	F [mm]	L [mm]	d [mm]	Hmot. [kg]
47T10/18-2	47T1018	6F	F22	18	57,45	55,45	60	40	37	47	10	0,253
47T10/19-2	47T1019	6F	F25	19	60,65	58,65	66	44	37	47	10	0,286
47T10/20-2	47T1020	6F	F25	20	63,80	61,80	66	46	37	47	12	0,322
47T10/22-2	47T1022	6F	F27	22	70,20	68,20	75	52	37	47	12	0,393
47T10/24-2	47T1024	6F	F29	24	76,55	74,55	83	58	37	47	12	0,475
47T10/25-2	47T1025	6F	F29	25	79,75	77,70	83	60	37	47	12	0,527
47T10/26-2	47T1026	6F	F30	26	82,90	80,90	87	60	37	47	12	0,564
47T10/27-2	47T1027	6F	F31	27	86,10	84,10	91	60	37	47	12	0,602
47T10/28-2	47T1028	6F	F32	28	89,25	87,25	93	60	37	47	12	0,642
47T10/30-2	47T1030	6F	F33	30	95,65	93,65	97	60	37	47	12	0,740
47T10/32-2	47T1032	6F	F35	32	102,00	100,00	106	65	37	47	12	0,844
47T10/36-2	47T1036	6F	F38	36	114,75	112,45	120	70	37	47	16	1,063
47T10/40-2	47T1040	6F	F41	40	127,45	125,45	131	80	37	47	16	1,371
47T10/44-0	47T1044	6		44	140,20	138,20		88	37	47	16	1,611
47T10/48-0	47T1048	6		48	152,95	150,95		95	37	47	16	1,913
47T10/60-0	47T1060	6		60	191,10	189,10		110	37	47	16	3,004

T 10 Rozteč 10 mm pro řemeny šířky 50 mm

Označení	Obj. č.	Typ	Typ příruby	Počet zubů	Dp [mm]	De [mm]	Df [mm]	Dm [mm]	F [mm]	L [mm]	d [mm]	Hmot. [kg]
66T10/18-2	66T1018	6F	F22	18	57,45	55,45	60	40	56	66	10	0,422
66T10/19-2	66T1019	6F	F25	19	60,65	58,65	66	44	56	66	10	0,466
66T10/20-2	66T1020	6F	F25	20	63,80	61,80	66	46	56	66	12	0,520
66T10/22-2	66T1022	6F	F27	22	70,20	68,20	75	52	56	66	12	0,640
66T10/24-2	66T1024	6F	F29	24	76,55	74,55	83	58	56	66	12	0,736
66T10/25-2	66T1025	6F	F29	25	79,75	77,70	83	60	56	66	12	0,766
66T10/26-2	66T1026	6F	F30	26	82,90	80,90	87	60	56	66	12	0,845
66T10/27-2	66T1027	6F	F31	27	86,10	84,10	91	60	56	66	12	0,946
66T10/28-2	66T1028	6F	F32	28	89,25	87,25	93	60	56	66	12	0,110
66T10/30-2	66T1030	6F	F33	30	95,65	93,65	97	60	56	66	12	1,169
66T10/32-2	66T1032	6F	F35	32	102,00	100,00	106	65	56	66	12	1,300
66T10/36-2	66T1036	6F	F38	36	114,75	112,75	120	70	56	66	16	1,637
66T10/40-2	66T1040	6F	F41	40	127,45	125,45	131	80	56	66	16	1,999
66T10/44-0	66T1044	6		44	140,20	138,20		88	56	66	16	2,420
66T10/48-0	66T1048	6		48	152,95	150,95		95	56	66	16	2,830
66T10/60-0	66T1060	6		60	191,10	189,10		110	56	66	16	4,366

Řemenice pro řemeny T 20

Materiál: šedá litina

T 20 Rozteč 20 mm pro řemeny šířky 32 mm

Označení	Obj. č.	Typ	Typ příruby	Počet zubů	De [mm]	Df [mm]	Dm [mm]	F [mm]	L [mm]	d [mm]
53T20/18-2	53T2018	6F	F38	18	111,75	120	80	38	53	15
53T20/20-2	53T2020	6F	F43	20	124,50	138	90	38	53	15
53T20/22-2	53T2022	6F	F46	22	137,20	146	90	38	53	15
53T20/24-2	53T2024	6F	F50	24	149,95	158	95	38	53	15
53T20/25-2	53T2025	6F	F52	25	156,30	168	95	38	53	15
53T20/30-2	53T2030	6F	F59	30	188,15	200	110	38	53	15
53T20/32-2	53T2032	6W		32	200,85		110	38	53	18
53T20/36-2	53T2036	6W		36	226,35		110	38	53	18
53T20/40-2	53T2040	6A		40	251,80		110	38	53	20
53T20/48-2	53T2048	6A		48	302,70		130	38	53	20
53T20/60-2	53T2060	6A		60	379,10		130	38	53	20
53T20/72-2	53T2072	6A		72	455,50		140	38	53	20

Typ 6F

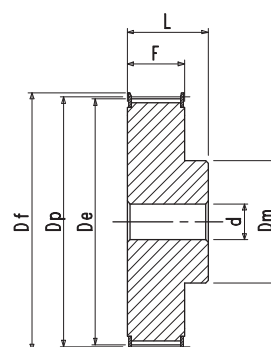

T 20 Rozteč 20 mm pro řemeny šířky 50 mm

Označení	Obj. č.	Typ	Typ příruby	Počet zubů	De [mm]	Df [mm]	Dm [mm]	F [mm]	L [mm]	d [mm]
71T20/18-2	71T2018	6F	F38	18	111,75	120	80	56	71	18
71T20/20-2	71T2020	6F	F43	20	124,50	138	90	56	71	18
71T20/22-2	71T2022	6F	F46	22	137,20	146	90	56	71	18
71T20/24-2	71T2024	6F	F50	24	149,95	158	95	56	71	18
71T20/25-2	71T2025	6F	F52	25	156,30	168	95	56	71	18
71T20/30-2	71T2030	6F	F59	30	188,15	200	110	56	71	18
71T20/32-2	71T2032	6W		32	200,85		110	56	71	20
71T20/36-2	71T2036	6W		36	226,35		110	56	71	20
71T20/40-2	71T2040	6A		40	251,80		110	56	71	20
71T20/48-2	71T2048	6A		48	302,70		130	56	71	24
71T20/60-2	71T2060	6A		60	379,10		130	56	71	24
71T20/72-2	71T2072	6A		72	455,50		140	56	71	24

Typ 6W

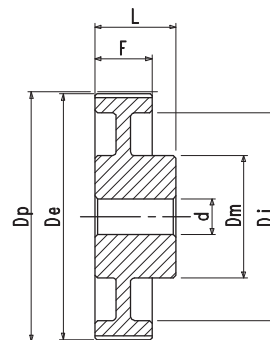

T 20 Rozteč 20 mm pro řemeny šířky 100 mm

Označení	Obj. č.	Typ	Typ příruby	Počet zubů	De [mm]	Df [mm]	Dm [mm]	F [mm]	L [mm]	d [mm]
123T20/18-2	123T2018	6F	F38	18	111,75	120	80	108	123	24
123T20/20-2	123T2020	6F	F43	20	124,50	138	90	108	123	24
123T20/22-2	123T2022	6F	F46	22	137,20	146	90	108	123	24
123T20/24-2	123T2024	6F	F50	24	149,95	158	95	108	123	24
123T20/25-2	123T2025	6F	F52	25	156,30	168	95	108	123	24
123T20/30-2	123T2030	6F	F59	30	188,15	200	110	108	123	24
123T20/32-2	123T2032	6W		32	200,85		110	108	123	32
123T20/36-2	123T2036	6W		36	226,35		110	108	123	32
123T20/40-2	123T2040	6A		40	251,80		110	108	123	32
123T20/48-2	123T2048	6A		48	302,70		130	108	123	32
123T20/60-2	123T2060	6A		60	379,10		130	108	123	32
123T20/72-2	123T2072	6A		72	455,50		140	108	123	32

Typ 6A

