

SLIDE WAY

The NB slide way is a non-recirculating linear motion bearing utilizing precision rollers. It is used primarily in optical and measurement equipment where high precision movement is required.

STRUCTURE AND ADVANTAGES

The NB slide way NV type comprises precisely ground rails and R-retainers with built-in STUDROLLERS and precision rollers. The rails have been optimally designed so that the STUDROLLERS move smoothly, and the STUDROLLERS and precision rollers incorporated in the R-retainers enable slip-free operation between the raceway surface and the rollers resulting in motion with minimal frictional resistance. SV and SVW types consist of precision ground rails and precision caged-rollers. Since caged-rollers do not recirculate, there is only a minimum frictional resistance fluctuation. Also, there is a minimum difference between the static and dynamic frictional resistances.

Non-slip!

STUDROLLER System (Rivet Roller Structure)

The STUDROLLER system is based on a new concept to provide complete prevention of roller cage slippage during operation. This system permits usage in all orientations and positions.

Figure G-1 STUDROLLER System



Suitable for Minute Motion

Because the frictional resistance is extremely small and there is only little difference between the static and dynamic frictional resistances, the NB slide way is well suited for minute motion, resulting in highly accurate linear movement.

Low-Speed Stability

Since the frictional resistance fluctuation is small even under low-load conditions, stable motion is obtained at from low to high speeds.

High Rigidity and High Load Capacity

Compared to the ball elements, the rollers provide a larger contact area and less elastic deformation, thus the NB slide way has high rigidity and high load capacity. With new NV rail design, the roller contact area is increased by 30 to 58% (Figure G-2). The number of effective rollers is increased by narrowing the roller pitch. Thus, the NV type has the load rating that is 1.3 to 2.5 times that of the SV type.

Low Noise

The slide way never produces recirculation noise nor roller-contact noise due to a use of roller cage, resulting in quiet motion.

All Stainless Steel Type Available

The anti-corrosion SVS/SVWS slide ways have all stainless steel components, making them ideal for use in clean room applications.

Figure G-2 Roller Contact Profile

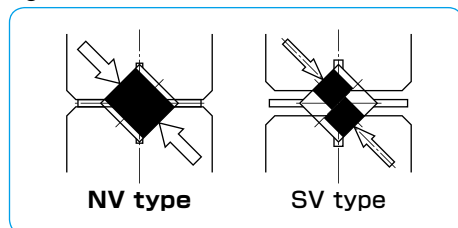

Figure G-3 Structure of NV type

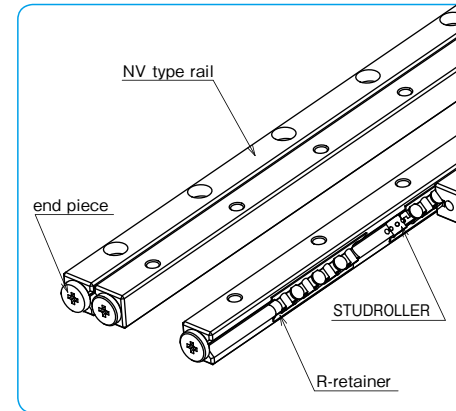
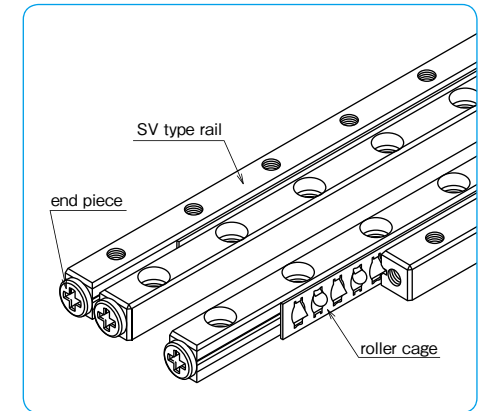

Figure G-4 Structure of SV type



※To the NV type, fastening plates are attached for the purpose of maintaining the center position of the R-retainer before assembly. Please see Installation Procedure on page G-7 and remove the fastening plates before use.

TYPES

NV type



P.G-10

The NV slide way consists of a set of four rails, two R-retainers, and eight end pieces. It permits flexible design of the table which will best suit your application. The NVS type is available with stainless steel rails and resin retainers, which is suitable for anti-corrosion requirements.

SV type

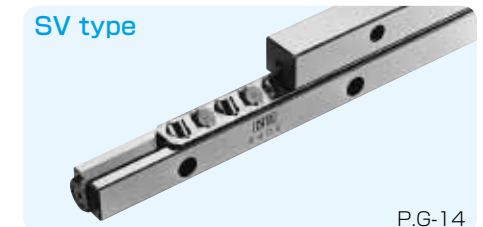

P.G-14

The SV slide way consists of a set of four rails, two R type roller cages, which have precision rollers in a cross arrangement, and eight end pieces. The all stainless steel option makes it suitable for use in corrosive environments.

SVW type

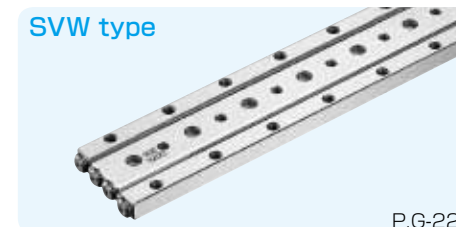

P.G-22

The SVW slide way consists of two SV-type rails, one W type rail, two R type roller cages, and eight end pieces. The use of a W-type rail serves for a compact design. The SVWS type is also available with all stainless steel components.

ACCURACY

The accuracy of the slide way is represented as parallelism measured across the full length with a method shown in Figure G-6. It is classified as high (blank), precision (P), or ultra precision (UP). Special accuracies can also be accommodated. Please contact NB for details.

Figure G-5 Parallelism

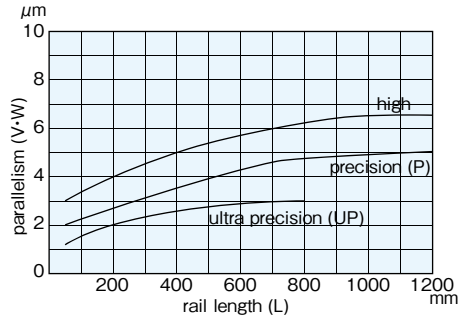
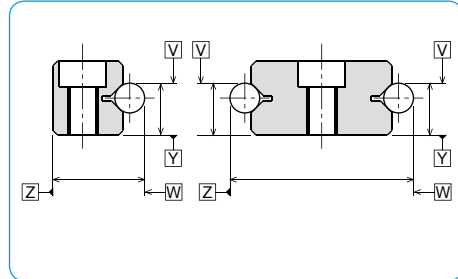

Figure G-6 Accuracy Measurement Method



Ultra precision grade is available from size 1 to size 9.

RATED LIFE

The life of the slide way and the slide table is calculated with the following equations:

Rated Life

$$L = \left(\frac{f_T \cdot C}{f_W \cdot P} \right)^{10/3} \cdot 50$$

L: rated life (km) f_T : temperature coefficient f_W : applied load coefficient
 C: basic dynamic load rating (N) P: applied load (N)
 ※ Please refer to page Eng-5 for the coefficients.

Life Time

$$L_h = \frac{L \cdot 10^3}{2 \cdot l_s \cdot n \cdot 60}$$

L_h : life time (hr) l_s : stroke length (m)
 n: number of cycles per minute (cpm)

LOAD RATING

The load rating for the slide way is obtained using the equations listed in Table G-1.

Table G-1 Load Rating

condition	single-rail usage	single-rail vertical usage	double-rail parallel usage
direction of load			
basic dynamic load rating C	$C = \left(2P \left(\frac{Z}{2} - 1 \right) \right)^{1/36} \cdot \left(\frac{Z}{2} \right)^{3/4} \cdot C_1$	$C = \left(2P \left(\frac{Z}{2} - 1 \right) \right)^{1/36} \cdot \left(\frac{Z}{2} \right)^{3/4} \cdot 2^{7/9} \cdot C_1$	
basic static load rating C_0	$C_0 = \frac{Z}{2} \cdot C_{01}$	$C_0 = \frac{Z}{2} \cdot C_{01} \cdot 2$	
allowable load F	$F = \frac{Z}{2} \cdot F_1$	$F = \frac{Z}{2} \cdot F_1 \cdot 2$	

C: basic dynamic load rating (N) C_0 : basic static load rating (N) F: allowable load (N) C_1 : basic dynamic load rating per roller (N)
 C_{01} : basic static load rating per roller (N) F_1 : allowable load per roller (N)
 Z: number of rollers per cage Z/2: number of effective rollers (round down to whole number) P: roller pitch (mm)

The load rating of the NV type differs depending on the direction of the load.

Table G-2 Change of Load Rating Corresponding to Load Direction

basic dynamic load rating	normal vertical direction	$1.0 \times C$
	horizontal direction	$0.85 \times C$
	reverse vertical direction	$0.7 \times C$
basic static load rating	normal vertical direction	$1.0 \times C_0$
	horizontal direction	$0.85 \times C_0$
	reverse vertical direction	$0.7 \times C_0$

※ There may be a difference depending on the size. Please contact NB for details.
 Consideration has been given to holes for STUDROLLERS in the raceway surface in calculation of load ratings.

Figure G-7 Direction of Load

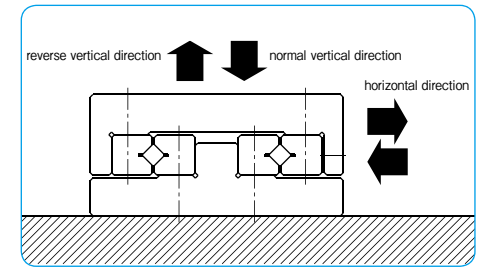

R·RS TYPE

— Standard Roller Cage —
 part number structure

example **RS 6 - 15Z**

specification
 R: standard roller
 RS: stainless steel roller

number of rollers
 size

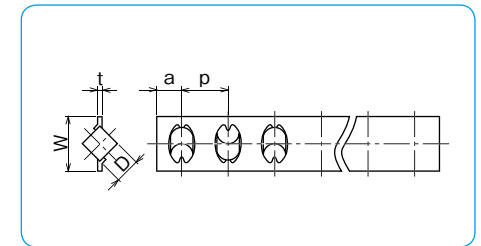

part number		D	t	W	p	a	C_1	C_{01}	F_1
standard	anti-corrosion	mm	mm	mm	mm	mm	N	N	N
R 1	RS1	1.5	0.2	3.8	2.5	2	154	119	39.8
R 2	RS2	2	0.3	5.6	4	2.5	360	293	97.8
R 3	RS3	3	0.4	7.6	5	3	824	649	216
R 4	RS4	4	0.4	10.4	7	4.5	1,660	1,320	442
R 6	RS6	6	0.7	14	8.5	5.5	3,840	2,960	987
R 9	—	9	0.7	19	14	7.5	9,330	7,070	2,350
R12	—	12	1.0	25	20	10	18,900	14,500	4,840

cage material: stainless steel C_1 : dynamic load rating per roller C_{01} : static load rating per roller
 F_1 : allowable load per roller

RA·RAS TYPE

— Aluminum Roller Cage —
 part number structure

example **RAS 6 - 15Z**

specification
 RA: standard roller
 RAS: stainless steel roller

number of rollers
 size

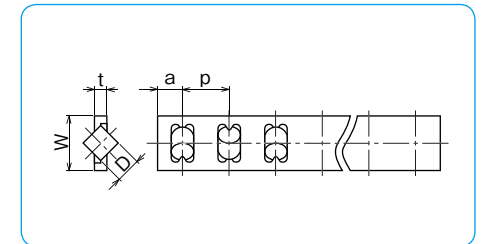

part number		D	t	W	p	a	C_1	C_{01}	F_1
standard	anti-corrosion	mm	mm	mm	mm	mm	N	N	N
RA3	RAS3	3	1.2	7.6	5	3	824	649	216
RA4	RAS4	4	1.4	10.4	7	4.5	1,660	1,320	442
RA6	RAS6	6	2.1	14	8.5	5.5	3,840	2,960	987
RA9	—	9	3.0	20	14	7.5	9,330	7,070	2,350

cage material: aluminum alloy C_1 : dynamic load rating per roller C_{01} : static load rating per roller
 F_1 : allowable load per roller

STROKE

Please contact NB for a non-standard stroke length for the NV type. When the stroke of SV type or SVW type is changed, the stroke length must be determined and the load rating should be re-estimated as follows.

Stroke of SV type, SVW type

When the slide way moves along the rail, the cage moves half the distance traveled by the slide way in the same direction. Therefore, although the work may be fixed on the table, the distance between the load center and the cage center will change. To achieve stable accuracy, determine the stroke and the length of the rail as follows.

Figure G-8

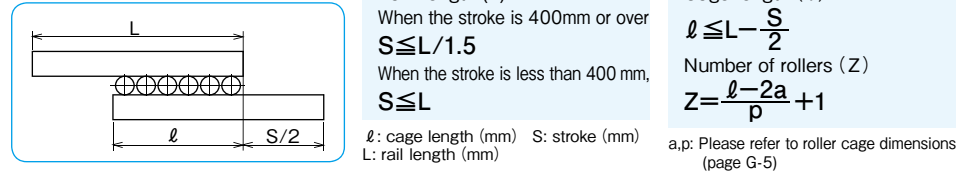

LUBRICATION AND DUST PREVENTION

Lubrication

The slide way is pre-lubricated with lithium soap-based grease prior to shipment for immediate use. Make sure to relubricate with a similar type of grease periodically according to the operating conditions. NB also provides low dust generation grease. Please refer to page Eng-39 for details.

Dust Prevention

Foreign particles or dust in the slide way affects the motion accuracy and shortens the life time. In a harsh environment please provide side covers for dust prevention. (refer to Figure G-9)

Figure G-9 Example of Dust Prevention Mechanism

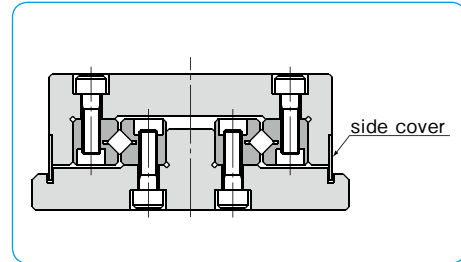

MOUNTING

Example

Figure G-10 NV type, SV type

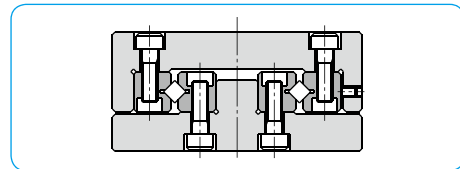
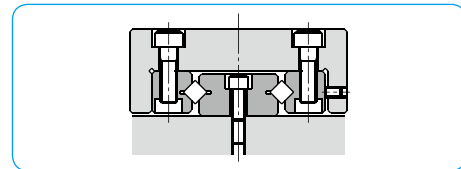

Figure G-11 SVW type



Accuracy of Mounting Surface

To maximize the performance of the NB slide way, it is recommended that the accuracy of the mounting surface to be equal to or greater than the degree of parallelism of the slide way.

- Parallelism of surface 1 against surface A
- Perpendicularity of surface 2 against surface A
- Parallelism of surface 3 against surface B
- Perpendicularity of surface 4 against surface B
- Parallelism of surface 2 against surface C
- Parallelism of surface 4 against surface C

Figure G-12 Accuracy of Mounting Surface

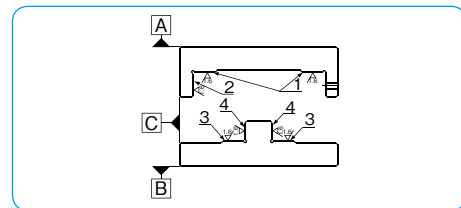

INSTALLATION PROCEDURE OF NV TYPE

Installation Procedure

※Please read "Use and Handling Precautions" before installation.

- (1) Remove burrs, scratches, and dust from the rail-mounting surface of the bed and the table, be careful to prevent contamination during assembly.
- (2) Apply low-viscosity oil to the contact surfaces, and align the bed and the table. (Figure G-13a)
- (3) Set the reference surface onto the mounting surface with the rails fastened. Set the table in the center position, and tighten the adjustment screws lightly so that almost no gap remains. (Figure G-13b)
- (4) Keep the table in the center, tighten the rail mounting bolts lightly, loosen the end pieces of both ends, and remove the fastening plates. Following this, lightly retighten the end pieces.
- (5) While maintaining the conditions of (4), gently move the assembly through its stroke to check if the maximum stroke is secured, and if there is no irregularity.
- (6) Move the table to the center and tighten only the adjustment screws on the R-retainer with the recommended torque shown in Table G-3. (Figure G-13c)
- (7) Gently move the table to one stroke end, and check that the table has surely come into contact with the external mechanical stopper. Following this, tighten the adjustment screws in the same manner as (6). (Figure G-13d)
- (8) Move the table to the opposite stroke end, and tighten in the same manner as (6). (Figure G-13e)
- (9) Fasten the mounting screws on rails 1, 2, and 3 by tightening with the recommended torque shown in Table G-4. (Figure G-13f)
- (10) Set the dial indicators to the center of the table and to the side (reference surface) of the table. (Figure G-13g)
- (11) Perform the final preload adjustment. While moving the table back and forth, repeat steps (6) to (8) until the dial indicators show a minimum deviation.
- (12) Fasten rail 4 securely with the recommended torque. As for the adjustment screws, successively tighten the mounting screws on the R-retainer by moving the table.
- (13) Recheck the motion accuracy while moving the table.
- (14) Tighten the end pieces finally.

Figure G-13 Installation Method

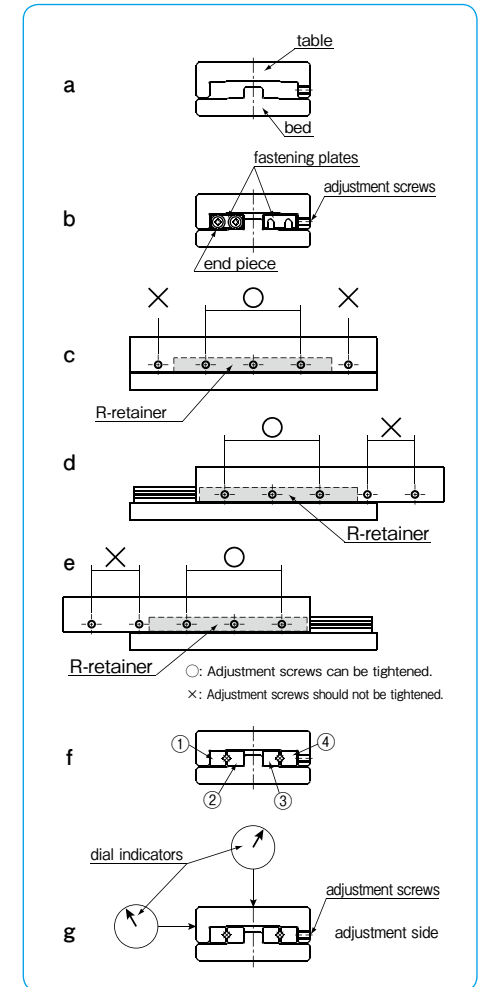

INSTALLATION PROCEDURE OF SV TYPE

Installation Procedure

- (1) Remove burrs, scratches, and dust from the rail-mounting surface of the bed and the table, be careful to prevent contamination during assembly.
- (2) Apply low-viscosity oil to contact surfaces. Attach rails ①-③ by tightening screws with the recommended torque (Table G-4). (Figure G-14a)
- (3) Temporarily attach rail ④ on the adjustment side. (Figure G-14b)
- (4) Remove end pieces on one end. Carefully insert roller cages between rails. (Figure G-14c)
- (5) Re-attach end pieces.
- (6) Move the table slowly to each stroke end to position roller cages at the center of the rails.
- (7) Set the dial indicators to the center of the table and to the side (reference surface) of the table. (Figure G-14d)
- (8) Move the table to one stroke end. Lightly tighten adjustment screws on the roller cage. (Figure G-14e)
- (9) Move the table to the opposite stroke end. Similarly lightly tighten adjustment screws on the roller cage. (Figure G-14f)
- (10) Move table to the center and lightly tighten center adjustment screws. (Figure G-14g)
- (11) Repeat steps (8) ~ (10) until the indicators show a minimum deviation. Please do not apply an excessive preload.
- (12) Make final adjustment of preload. Repeat steps (8) ~ (10) and tighten the adjustment screws with the recommended torque listed in Table G-3.
- (13) Fasten the rail ④ securely with the recommended torque. As with the adjustment screws, successively tighten the mounting screws by moving the table.

Figure G-14 Installation Method

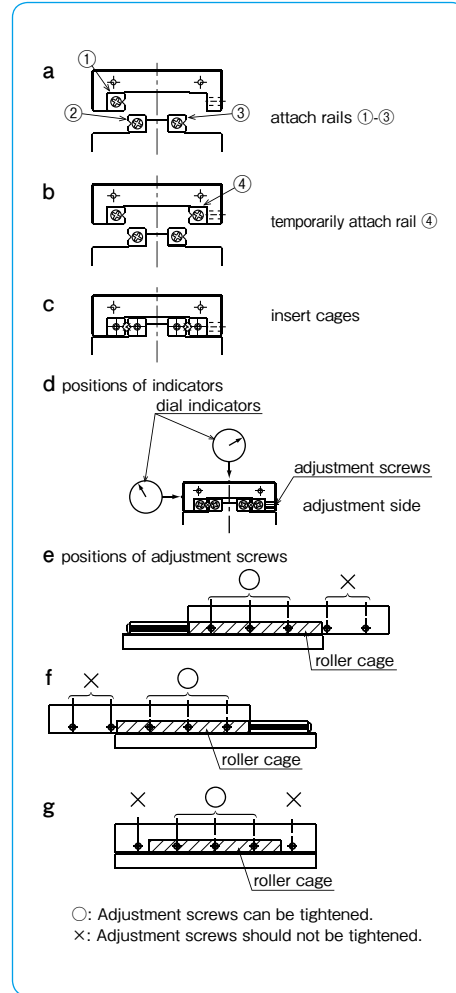

Table G-3 Recommended Torque for Adjustment Screw Unit/N·m

part number	size	torque
SV1	M2	0.008
NV2, SV2	M3	0.012
NV3, SV3	M4	0.05
NV4, SV4	M4	0.08
NV6, SV6	M5	0.20
NV9, SV9	M6	0.40

Table G-4 Recommended Torque for Mounting screw Unit/N·m

size	torque
M2	0.4
M3	1.4
M4	3.2
M5	6.6
M6	11.2
M8	27.6

(for steel alloy screw)

SPECIAL MOUNTING SCREW BT TYPE

To install the slide way using its counterbore, use of the BT type special mounting screw is recommended.

Figure G-15 Special Mounting Screw

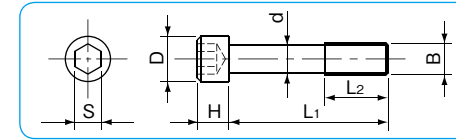

Table G-5 Special Mounting Screw

part number	B	d	D	H	L1	L2	S	applicable size
BT 3	M3	2.3	5	3	12	5	2.5	NV 3, SV 3
BT 4	M4	3.1	5.8	4	15	7	3	NV 4, SV 4
BT 6	M5	3.9	8	5	20	8	4	NV 6, SV 6
BT 9	M6	4.6	8.5	6	30	12	5	NV 9, SV 9
BT12	M8	6.25	11.3	8	40	17	6	NV12, SV12

USE AND HANDLING PRECAUTIONS

Careful Handling

Dropping the slide way causes the rolling elements to make dents in the raceway surface. This will prevent smooth motion and will also affect accuracy. Be sure to handle the product with care. The NV type is packaged as a set of rails and R-retainers. Do not separate or disassemble until assembly/installation is completed. Precision is not guaranteed if disassembled.

Fastening Plates

For the NV type, fastening plates are attached at both end faces of the rails to maintain the R-retainer center position prior to assembly. The fastening plates are not required after the NV type is mounted to a table and bed, however, when removal of the NV type is necessary such as when it will be reassembled, be sure to return the R-retainer to the proper center position, secure the fastening plates with the end pieces, and then remove the NV type.

Specified Allowable Stroke

For the NV type, exceeding the specified stroke (over-stroke) shall cause the raceway surface of the rail to be damaged and the performance of the STUDROLLER to drastically deteriorate. Be sure to provide external mechanical stoppers.

Adjustment

Using the product with insufficient accuracy of the mounting surface or before adjusting the preload will cause the motion accuracy of the product to drop and will have a negative influence upon product life and accuracy. Make sure to assemble, install, and adjust the product with care.

Caution against Excess Preload

It is essential to give preload on the Slide Way products in order to assure rigidity and accuracy. However, excess preload causes damage on the raceways and roller cages/R-retainers. On installation, please follow the installation procedure and recommended torque on page G-8.

Operating Temperature

The NV type uses resin parts. Please use the product in environments that are lower than 80°C.

Use as a Set

The accuracy of the rails has been matched within each set. Note that the accuracy will be affected when the rails of different sets are combined.

Allowable Load

The allowable load is a load under which the sum of elastic deformations of the rolling element and the raceway in the contact area subject to the maximum contact stress is small enough to guarantee smooth rolling movement. When very smooth and highly accurate linear motion is required, make sure to use the product within the allowable load.

Cage Slippage

For the SV/SVW type, the cage can slip under high-speed motion, vertical application, unbalanced-loading, and vibrating conditions. It is advised that the stroke be set with sufficient margin and an excessive preload should be avoided. It is also recommended that the rails be cycled to perform the maximum stroke several times, so that the cage returns to its central position.

End Pieces

End pieces are attached to each end of the slide way to prevent removal of the cage. Do not use them as a mechanical stopper.

Knock Pin Hole

When using SVW type knock pin holes to attach a slide way, please do the hole-machining on the mounting surface after attaching the W type rail. After machining, remove the chips completely and wash as required.

NV TYPE

-NV2/NV3/NV4-

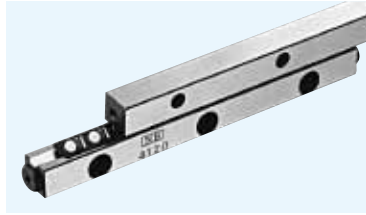

part number structure

example **NVS 2 150-41Z-UP**

specification NV: standard NVS: anti-corrosion	size	rail length	number of rollers
--	------	-------------	-------------------

accuracy grade
blank: high
P: precision
UP: ultra precision

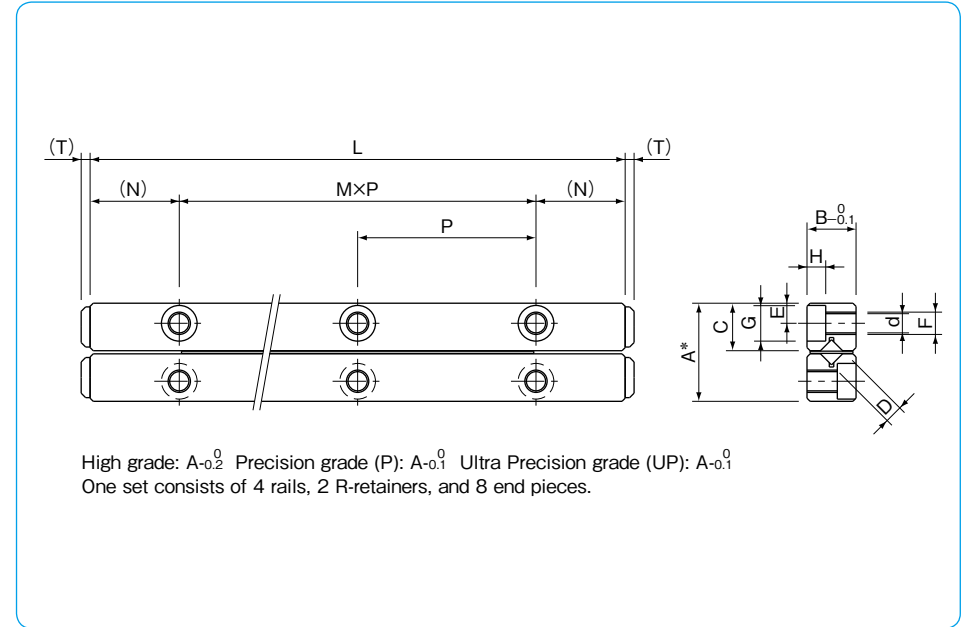

part number		stroke	roller diameter	number of rollers	L	A	B	C				
standard	anti-corrosion	ST mm	D mm	Z	mm	mm	mm	mm				
NV2030-5Z	NVS2030-5Z	18	2	5	30	12	6	5.7				
2045-9Z	2045-9Z	25		9	45							
2060-15Z	2060-15Z	30		15	60							
2075-19Z	2075-19Z	40		19	75							
2090-23Z	2090-23Z	50		23	90							
2105-27Z	2105-27Z	65		27	105							
2120-33Z	2120-33Z	70		33	120							
2135-37Z	2135-37Z	80		37	135							
2150-41Z	2150-41Z	90		41	150							
2165-47Z	2165-47Z	95		47	165							
2180-51Z	2180-51Z	100	51	180								
NV3050-9Z	NVS3050-9Z	25	3	9	50	18	8	8.65				
3075-13Z	3075-13Z	48		13	75							
3100-19Z	3100-19Z	60		19	100							
3125-23Z	3125-23Z	83		23	125							
3150-29Z	3150-29Z	90		29	150							
3175-35Z	3175-35Z	103		35	175							
3200-41Z	3200-41Z	113		41	200							
3225-43Z	3225-43Z	150		43	225							
NV4080-9Z	NVS4080-9Z	60		4	9				80	22	11	10.65
4120-17Z	4120-17Z	75			17				120			
4160-23Z	4160-23Z	105	23		160							
4200-29Z	4200-29Z	130	29		200							
4240-37Z	4240-37Z	143	37		240							
4280-43Z	4280-43Z	170	43		280							

The basic static load rating is the value at the center of the stroke.

major dimensions								basic load rating		allowable	mass	size							
M×P	N	E	F	d	G	H	T	dynamic C	static Co	load F	(one set) g								
mm	mm	mm		mm	mm	mm	mm	N	N	N									
1×15	7.5	2.5	M3	2.55	4.4	2	2	1,360	1,520	500	33	2030							
2×15								2,330	3,050	1,010	49	2045							
3×15								3,990	6,110	2,030	62	2060							
4×15								4,740	7,630	2,540	74	2075							
5×15								5,460	9,160	3,050	91	2090							
6×15								6,160	10,600	3,560	103	2105							
7×15								6,830	12,200	4,070	120	2120							
8×15								7,490	13,700	4,580	132	2135							
9×15								8,130	15,200	5,090	149	2150							
10×15								9,370	18,300	6,110	161	2165							
11×15	9,970	19,800	6,620	174	2180														
1×25	12.5	3.5	M4	3.3	6	3.1	2	6,150	8,060	2,680	97	3050							
2×25								8,440	12,100	4,030	140	3075							
3×25								12,500	20,100	6,720	192	3100							
4×25								14,400	24,200	8,060	245	3125							
5×25								16,300	28,200	9,410	290	3150							
6×25								19,800	36,300	12,100	337	3175							
7×25								21,500	40,300	13,400	385	3200							
8×25								23,200	44,300	14,700	434	3225							
1×40								20	4.5	M5	4.3	8	4.2	2	12,100	15,700	5,250	265	4080
2×40															20,700	31,500	10,500	400	4120
3×40	28,500	47,200	15,700	530	4160														
4×40	32,100	55,100	18,300	660	4200														
5×40	39,000	70,900	23,600	800	4240														
6×40	45,600	86,600	28,800	930	4280														

1N≒0.102kgf

NV TYPE

-NV6/NV9/NV12-

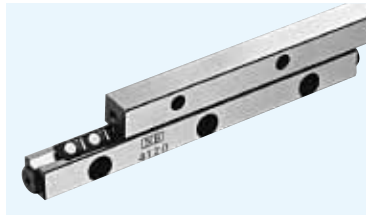

part number structure

example **NV 6 200- 19Z -UP**

NV type

size

rail length

accuracy grade
blank: high
P: precision
UP: ultra precision
 The UP grade is not available for NV 12

number of rollers

part number	stroke ST mm	roller diameter D mm	number of rollers Z	major dimensions						
				L mm	A mm	B mm	C mm	M×P mm	N mm	E mm
NV6100- 9Z	63	6	9	100	31	15	15.15	1×50	25	6
6150- 15Z	85		15	150				2×50		
6200- 19Z	135		19	200				3×50		
6250- 25Z	158		25	250				4×50		
6300- 31Z	180		31	300				5×50		
6350- 35Z	230		35	350				6×50		
6400- 39Z	275		39	400				7×50		
NV9200- 13Z	120		9	13				200		
9300- 21Z	170	21		300	2×100					
9400- 29Z	220	29		400	3×100					
9500- 35Z	300	35		500	4×100					
NV12300- 15Z	180	12	15	300	58	28	28.5	2×100	50	12
12400- 21Z	230		21	400				3×100		
12500- 27Z	280		27	500				4×100		
12600- 31Z	380		31	600				5×100		

The basic static load rating is the value at the center of the stroke.

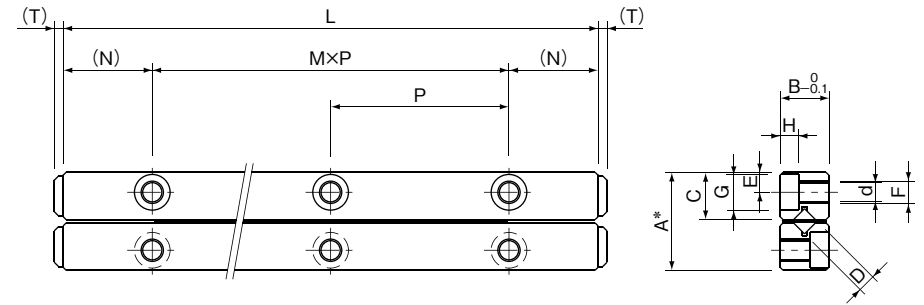

High grade: A-0.2 Precision grade (P): A-0.1 Ultra Precision grade (UP): A-0.0
 One set consists of 4 rails, 2 R-retainers, and 8 end pieces.

F	d	G	H	T	basic load rating		allowable load F N	mass (one set) g	size
					dynamic C N	static Co N			
M6	5.2	9.5	5.2	3	29,600	37,500	12,500	650	6100
					50,900	75,100	25,000	970	6150
					60,600	93,900	31,300	1,300	6200
					69,800	112,000	37,500	1,620	6250
					87,400	150,000	50,100	1,940	6300
					95,800	169,000	56,300	2,360	6350
					104,000	187,000	62,600	2,780	6400
					96,000	128,000	42,600	2,720	9200
M8	6.8	10.5	6.2	4	143,000	213,000	71,100	4,080	9300
					186,000	298,000	99,500	5,440	9400
					226,000	384,000	128,000	6,790	9500
					228,000	317,000	105,000	6,770	12300
M10	8.5	13.5	8.2	4	271,000	396,000	132,000	9,040	12400
					352,000	555,000	185,000	11,300	12500
					391,000	635,000	211,000	13,560	12600

1N≒0.102kgf

SV TYPE

-SV1/SV2-

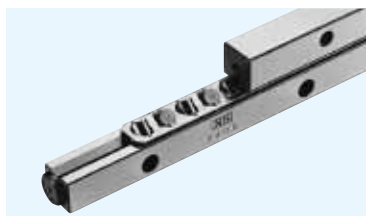

part number structure

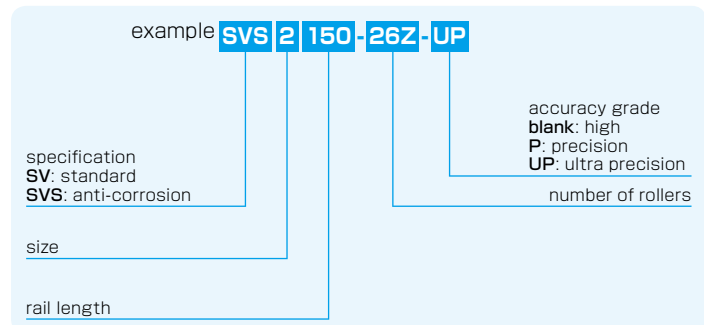

※Stainless steel rollers are used for anti-corrosion type. (refer to page G-5)

part number		stroke	roller diameter	number of rollers	L	A	B	C
standard	anti-corrosion	ST mm	D mm	Z	mm	mm	mm	mm
SV 1020-5Z	SVS 1020-5Z	12	1.5	5	20	8.5	4	3.8
1030-7Z	1030-7Z	20		7	30			
1040-10Z	1040-10Z	27		10	40			
1050-13Z	1050-13Z	32		13	50			
1060-16Z	1060-16Z	37		16	60			
1070-19Z	1070-19Z	42		19	70			
1080-21Z	1080-21Z	50		21	80			
SV 2030-5Z	SVS 2030-5Z	18		2	5			
2045-8Z	2045-8Z	24	8		45			
2060-11Z	2060-11Z	30	11		60			
2075-13Z	2075-13Z	44	13		75			
2090-16Z	2090-16Z	50	16		90			
2105-18Z	2105-18Z	64	18		105			
2120-21Z	2120-21Z	70	21		120			
2135-23Z	2135-23Z	84	23		135			
2150-26Z	2150-26Z	90	26		150			
2165-29Z	2165-29Z	95	29		165			
2180-32Z	2180-32Z	100	32		180			

※Maximum Rail Length (standard type only)

part number	Max. length
SV1	200mm
SV2	450mm

※Please contact NB for details.

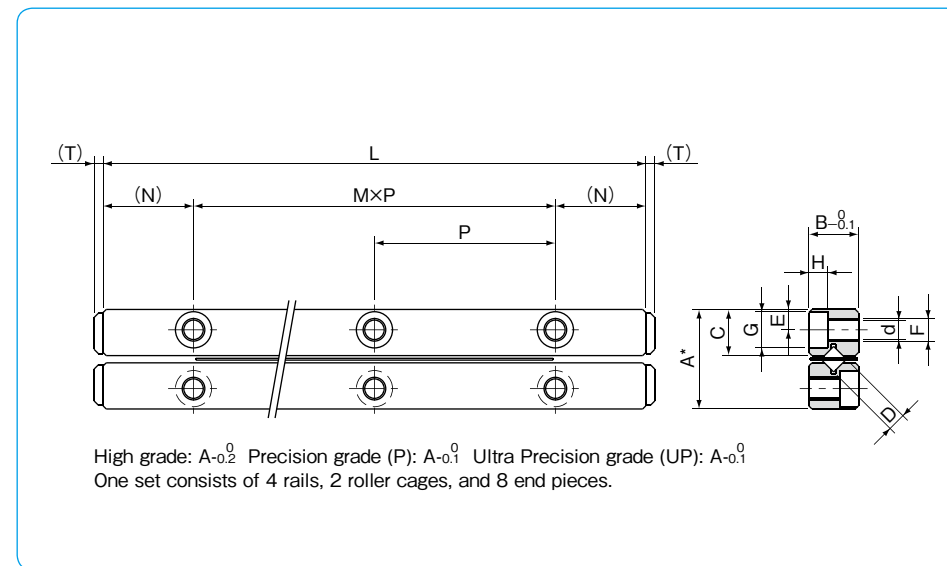

major dimensions								dynamic C N	static Co N	allowable load F N	mass (one set) g	size
M × P mm	N mm	E mm	F	d mm	G mm	H mm	T mm					
1 × 10	5	1.8	M2	1.65	3	1.4	0.8	464	476	158	11	1020
2 × 10								641	714	237	14	1030
3 × 10								959	1,190	396	18	1040
4 × 10								1,100	1,420	475	22	1050
5 × 10								1,380	1,900	633	26	1060
6 × 10								1,510	2,140	712	30	1070
7 × 10								1,650	2,380	792	34	1080
1 × 15								7.5	2.5	M3	2.55	4.4
2 × 15	1,900	2,340	780	42	2045							
3 × 15	2,270	2,930	976	55	2060							
4 × 15	2,620	3,510	1,170	69	2075							
5 × 15	3,280	4,680	1,560	83	2090							
6 × 15	3,590	5,270	1,750	96	2105							
7 × 15	3,900	5,860	1,950	110	2120							
8 × 15	4,210	6,440	2,140	123	2135							
9 × 15	4,790	7,610	2,530	137	2150							
10 × 15	5,080	8,200	2,730	151	2165							
11 × 15	5,640	9,370	3,120	165	2180							

1N ≒ 0.102kgf

SV TYPE

-SV3/SV4-

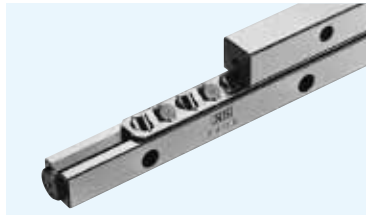

part number structure

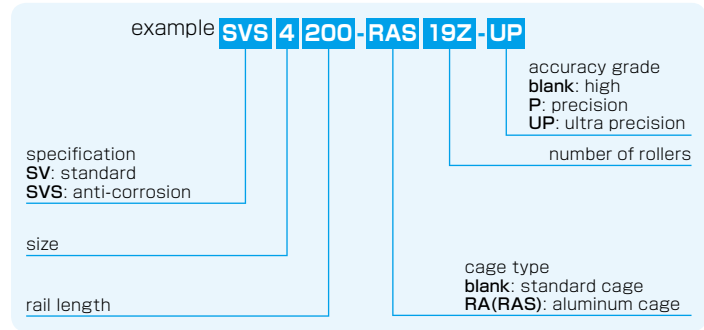

※Stainless steel rollers are used for anti-corrosion type. (refer to page G-5)

part number		stroke	roller diameter	number of rollers	L	A	B	C
standard	anti-corrosion	ST mm	D mm	Z	mm	mm	mm	mm
SV 3050-7Z	SVS 3050-7Z	28	3	7	50	18	8	8.3
3075-10Z	3075-10Z	48		10	75			
3100-14Z	3100-14Z	58		14	100			
3125-17Z	3125-17Z	78		17	125			
3150-21Z	3150-21Z	88		21	150			
3175-24Z	3175-24Z	105		24	175			
3200-28Z	3200-28Z	115		28	200			
3225-31Z	3225-31Z	135		31	225			
3250-35Z	3250-35Z	145		35	250			
3275-38Z	3275-38Z	165		38	275			
3300-42Z	3300-42Z	175		42	300			
3325-45Z	3325-45Z	195		45	325			
3350-49Z	3350-49Z	205		49	350			
SV 4080-7Z	SVS 4080-7Z	58		4	7			
4120-11Z	4120-11Z	82	11		120			
4160-15Z	4160-15Z	105	15		160			
4200-19Z	4200-19Z	130	19		200			
4240-23Z	4240-23Z	150	23		240			
4280-27Z	4280-27Z	175	27		280			
4320-31Z	4320-31Z	200	31		320			
4360-35Z	4360-35Z	225	35		360			
4400-39Z	4400-39Z	250	39		400			
4440-43Z	4440-43Z	270	43		440			
4480-47Z	4480-47Z	295	47		480			

※Maximum Rail Length (standard type only)

part number	Max. length
SV3	700mm
SV4	700mm

※Please contact NB for details.

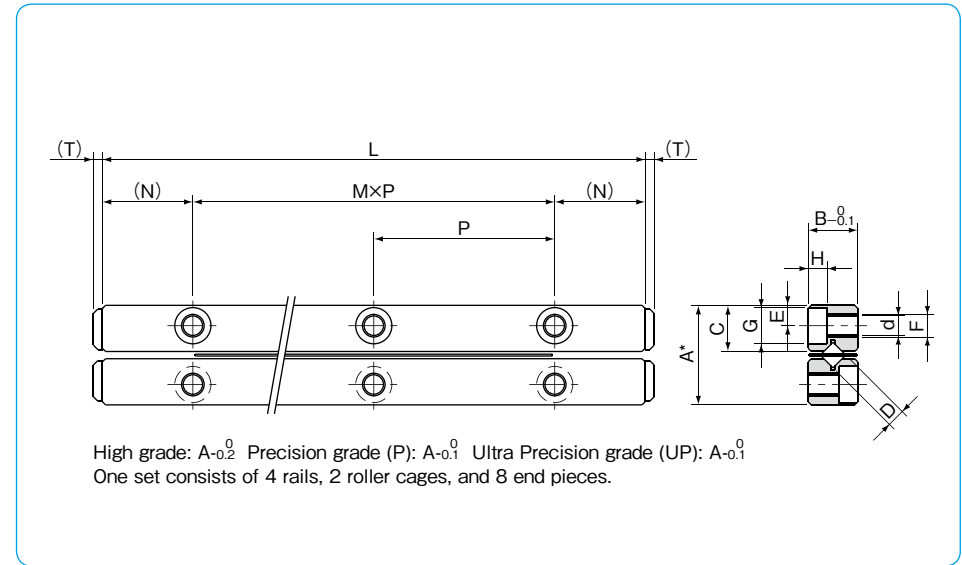

major dimensions								basic load rating		allowable	mass	size
M x P	N	E	F	d	G	H	T	dynamic C	static Co	load F	(one set) g	
mm	mm	mm		mm	mm	mm	mm	N	N	N		
1 x 25	12.5	3.5	M4	3.3	6	3.1	2	3,490	3,890	1,290	94	3050
2 x 25								5,230	6,490	2,160	135	3075
3 x 25								6,810	9,080	3,020	187	3100
4 x 25								7,560	10,300	3,450	234	3125
5 x 25								9,000	12,900	4,320	281	3150
6 x 25								10,300	15,500	5,180	327	3175
7 x 25								11,700	18,100	6,040	374	3200
8 x 25								12,300	19,400	6,480	421	3225
9 x 25								13,600	22,000	7,340	468	3250
10 x 25								14,800	24,600	8,200	514	3275
11 x 25								16,000	27,200	9,070	561	3300
12 x 25								16,600	28,500	9,500	608	3325
13 x 25								17,800	31,100	10,300	655	3350
1 x 40								20	4.5	M5	4.3	8
2 x 40	10,600	13,200	4,400	385	4120							
3 x 40	13,800	18,400	6,160	510	4160							
4 x 40	16,800	23,700	7,920	635	4200							
5 x 40	19,700	29,000	9,680	770	4240							
6 x 40	22,400	34,300	11,400	905	4280							
7 x 40	25,100	39,600	13,200	1,020	4320							
8 x 40	27,600	44,800	14,900	1,160	4360							
9 x 40	30,200	50,100	16,700	1,280	4400							
10 x 40	32,600	55,400	18,400	1,410	4440							
11 x 40	35,000	60,700	20,200	1,540	4480							

1N≒0.102kgf

SV TYPE

-SV6/SV9-

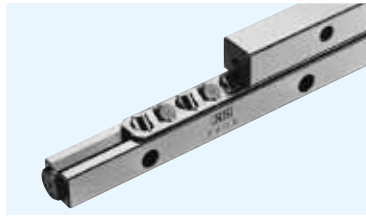

part number structure

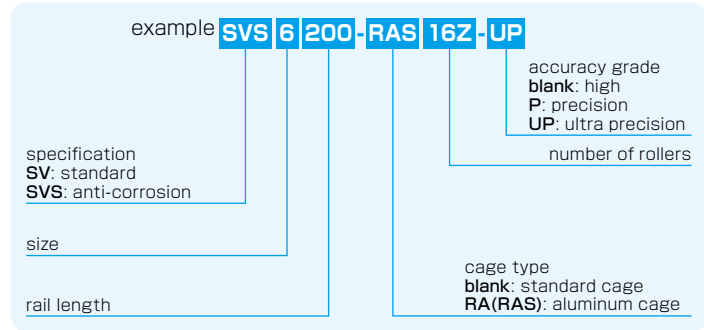

※Stainless steel rollers are used for anti-corrosion type. (refer to page G-5)

part number		stroke	roller diameter	number of rollers	L	A	B	C
standard	anti-corrosion	ST mm	D mm	Z	mm	mm	mm	mm
SV 6100-8Z	SVS 6100-8Z	55	6	8	100	31	15	14.2
6150-12Z	6150-12Z	85		12	150			
6200-16Z	6200-16Z	120		16	200			
6250-20Z	6250-20Z	150		20	250			
6300-24Z	6300-24Z	185		24	300			
6350-28Z	6350-28Z	215		28	350			
6400-32Z	6400-32Z	245		32	400			
6450-36Z	6450-36Z	280		36	450			
6500-40Z	6500-40Z	310		40	500			
6600-49Z	6600-49Z	360		49	600			
SV 9200-10Z	—	115	9	10	200	44	22	20.2
9300-15Z	—	175		15	300			
9400-20Z	—	235		20	400			
9500-25Z	—	295		25	500			
9600-30Z	—	355		30	600			
9700-35Z	—	415		35	700			
9800-40Z	—	475		40	800			
9900-45Z	—	535		45	900			
91000-50Z	—	595		50	1,000			

※Maximum Rail Length (standard type only)

part number	Max. length
SV6	700mm

※Please contact NB for details.

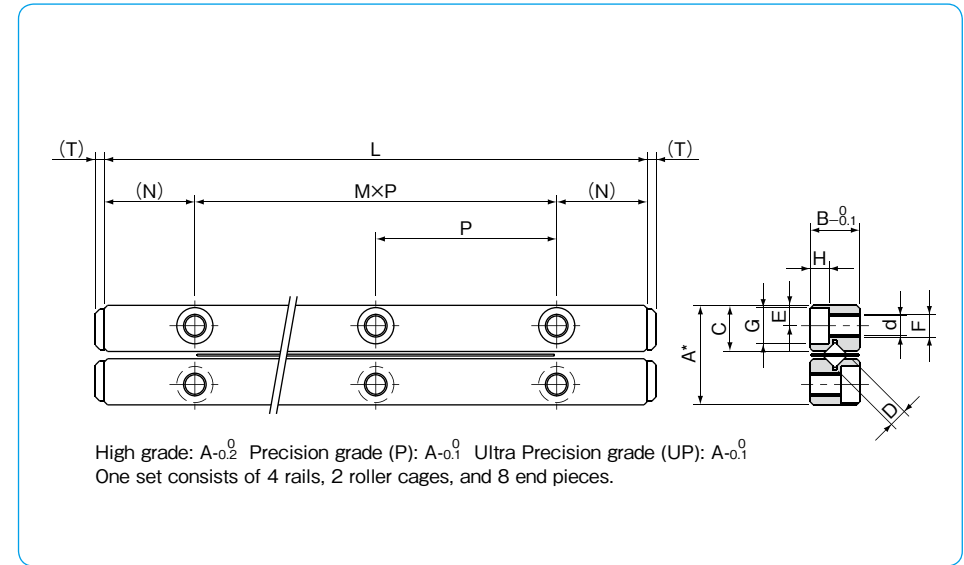

major dimensions								basic load rating		allowable	mass	size
M × P	N	E	F	d	G	H	T	dynamic C	static Co	load F	(one set) g	
mm	mm	mm	mm	mm	mm	mm	mm	N	N	N		
1 × 50	25	6	M6	5.2	9.5	5.2	3	20,700	23,600	7,880	628	6100
2 × 50								28,500	35,500	11,800	942	6150
3 × 50								35,700	47,300	15,700	1,260	6200
4 × 50								42,500	59,200	19,700	1,570	6250
5 × 50								49,000	71,000	23,600	1,880	6300
6 × 50								55,300	82,800	27,600	2,200	6350
7 × 50								61,400	94,700	31,500	2,510	6400
8 × 50								67,300	106,000	35,400	2,830	6450
9 × 50								73,100	118,000	39,400	3,140	6500
11 × 50								84,200	142,000	47,300	3,770	6600
1 × 100	50	9	M8	6.8	10.5	6.2	4	60,900	70,700	23,500	2,720	9200
2 × 100								79,300	98,900	32,900	4,030	9300
3 × 100								104,000	141,000	47,000	5,380	9400
4 × 100								120,000	169,000	56,400	6,700	9500
5 × 100								143,000	212,000	70,500	8,050	9600
6 × 100								158,000	240,000	79,900	9,230	9700
7 × 100								180,000	282,000	94,000	10,500	9800
8 × 100								193,000	311,000	103,000	11,900	9900
9 × 100								214,000	353,000	117,000	13,000	91000

1N≒0.102kgf

SV TYPE

-SV12-

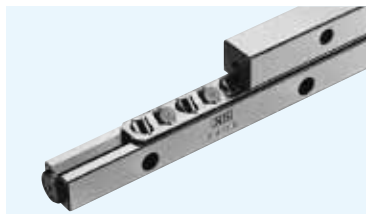

part number structure

example **SV 12 500- 17Z -P**

specification
SV: standard

size

rail length

accuracy grade
blank: high
P: precision

number of rollers

part number		stroke	roller diameter	number of rollers	L	A	B	C
standard	anti-corrosion	ST mm	D mm	Z	mm	mm	mm	mm
SV12300-10Z	—	200	12	10	300	58	28	27
12400-14Z	—	240		14	400			
12500-17Z	—	320		17	500			
12600-21Z	—	360		21	600			
12700-24Z	—	440		24	700			
12800-28Z	—	480		28	800			
12900-31Z	—	560		31	900			
121000-34Z	—	640		34	1,000			
121100-38Z	—	680		38	1,100			
121200-42Z	—	720		42	1,200			

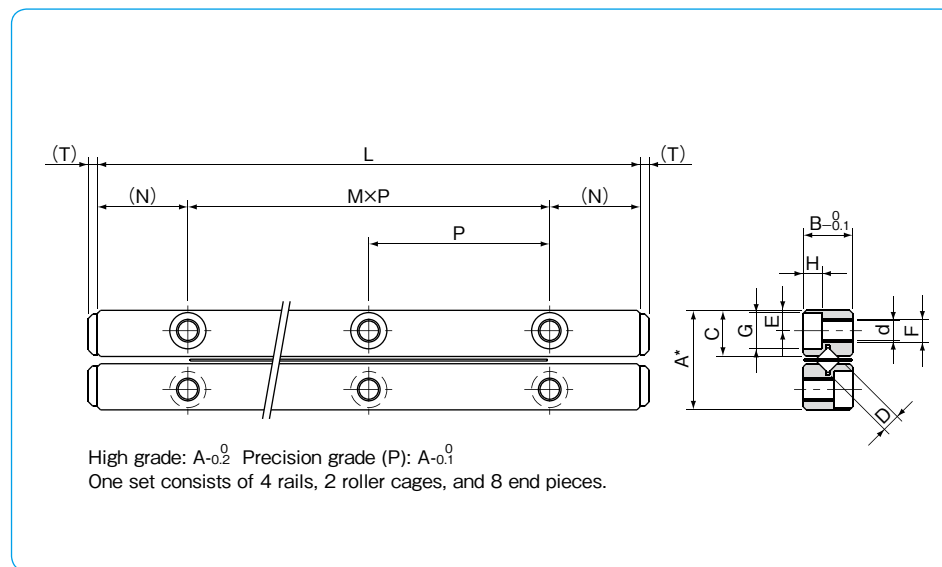

major dimensions								basic load rating dynamic C N	static Co N	allowable load F N	mass (one set) g	size
M×P mm	N mm	E mm	F	d mm	G mm	H mm	T mm					
2×100	50	12	M10	8.5	13.5	8.2	4	124,000	145,000	48,300	6,880	12300
3×100								162,000	203,000	67,600	9,090	12400
4×100								180,000	232,000	77,200	11,400	12500
5×100								214,000	290,000	96,600	13,700	12600
6×100								247,000	348,000	115,000	15,800	12700
7×100								279,000	406,000	135,000	18,200	12800
8×100								294,000	435,000	144,000	20,500	12900
9×100								324,000	493,000	164,000	22,800	121000
10×100								354,000	551,000	183,000	25,000	121100
11×100								382,000	609,000	202,000	27,300	121200

1N≒0.102kgf

SVW TYPE

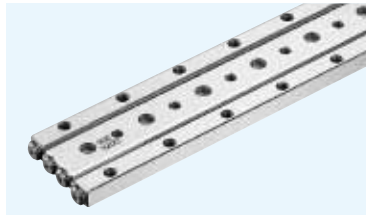

part number structure

example **SVWS 4 200-RAS 19Z-UP**

specification
SVW: standard
SVWS: anti-corrosion

size

rail length

accuracy grade
blank: high
P: precision
UP: ultra precision

number of rollers

cage type
blank: standard cage
RA: aluminum cage standard roller
RAS: aluminum cage stainless steel roller

※Refer to page G-5 for information on cage types.

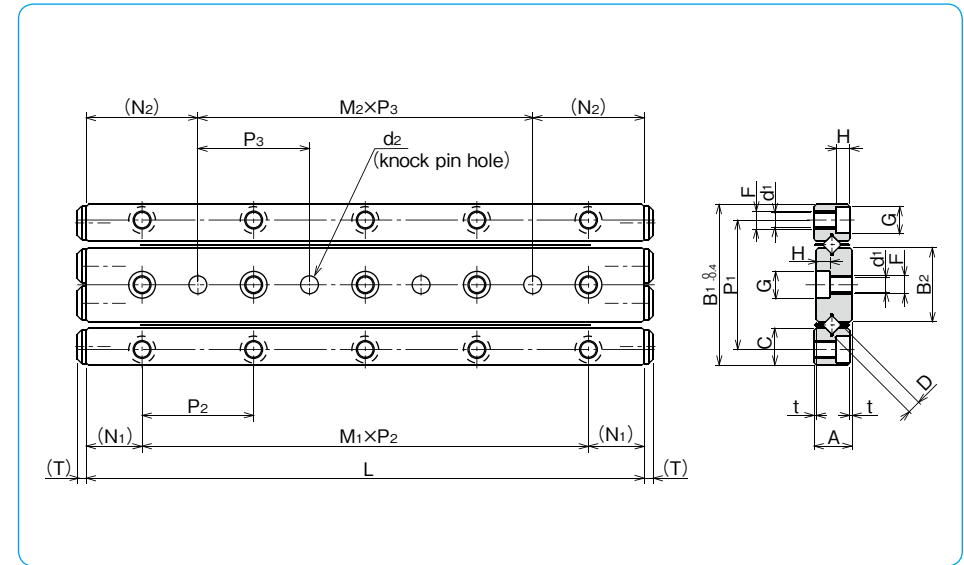

part number		stroke	roller diameter	number of rollers	L	A	t	B ₁	B ₂	C	P ₁	M ₁ × P ₂
standard	anti-corrosion	ST mm	D mm	Z	mm	mm	mm	mm	mm	mm	mm	mm
SVW 1020- 5Z	SVWS 1020- 5Z	12	1.5	5	20	4.5	0.5	17	7.6	3.8	13.4	1 × 10
1030- 7Z	1030- 7Z	20		7	30							2 × 10
1040-10Z	1040-10Z	27		10	40							3 × 10
1050-13Z	1050-13Z	32		13	50							4 × 10
1060-16Z	1060-16Z	37		16	60							5 × 10
1070-19Z	1070-19Z	42		19	70							6 × 10
1080-21Z	1080-21Z	50		21	80							7 × 10
SVW 2030- 5Z	SVWS 2030- 5Z	18	2	5	30	6.5	0.5	24	11	5.5	19	1 × 15
2045- 8Z	2045- 8Z	24		8	45							2 × 15
2060-11Z	2060-11Z	30		11	60							3 × 15
2075-13Z	2075-13Z	44		13	75							4 × 15
2090-16Z	2090-16Z	50		16	90							5 × 15
2105-18Z	2105-18Z	64		18	105							6 × 15
2120-21Z	2120-21Z	70		21	120							7 × 15
SVW 3050- 7Z	SVWS 3050- 7Z	28	3	7	50	8.5	0.5	36	16.6	8.3	29	1 × 25
3075-10Z	3075-10Z	48		10	75							2 × 25
3100-14Z	3100-14Z	58		14	100							3 × 25
3125-17Z	3125-17Z	78		17	125							4 × 25
3150-21Z	3150-21Z	88		21	150							5 × 25
3175-24Z	3175-24Z	105		24	175							6 × 25
3200-28Z	3200-28Z	115		28	200							7 × 25
SVW 4080- 7Z	SVWS 4080- 7Z	58	4	7	80	11.5	0.5	44	20.4	10.2	35	1 × 40
4120-11Z	4120-11Z	82		11	120							2 × 40
4160-15Z	4160-15Z	105		15	160							3 × 40
4200-19Z	4200-19Z	130		19	200							4 × 40
4240-23Z	4240-23Z	150		23	240							5 × 40
4280-27Z	4280-27Z	175		27	280							6 × 40

major dimensions									basic load rating				allowable		mass		size
N ₁	F	d ₁	G	H	M ₂ × P ₃	N ₂	d ₂	T	dynamic C	static Co	load F	load F	mass (one set) g	size			
mm	mm	mm	mm	mm	mm	mm	mm	mm	N	N	N	N	g				
5	M2	1.65	3	1.4	—	10	2 ^{+0.010} ₀	0.8	464	476	158	11	1020				
					1 × 10				641	714	237	14	1030				
					2 × 10				959	1,190	396	18	1040				
					3 × 10				1,100	1,420	475	22	1050				
					4 × 10				1,380	1,900	633	26	1060				
					5 × 10				1,510	2,140	712	30	1070				
					6 × 10				1,650	2,380	792	34	1080				
7.5	M3	2.55	4.4	2	—	15	3 ^{+0.010} ₀	2	1,090	1,170	390	28	2030				
					1 × 15				1,900	2,340	780	42	2045				
					2 × 15				2,270	2,930	976	55	2060				
					3 × 15				2,620	3,510	1,170	69	2075				
					4 × 15				3,280	4,680	1,560	83	2090				
					5 × 15				3,590	5,270	1,750	96	2105				
					6 × 15				3,900	5,860	1,950	110	2120				
12.5	M4	3.3	6	3.1	—	25	4 ^{+0.012} ₀	2	3,490	3,890	1,290	94	3050				
					1 × 25				5,230	6,490	2,160	135	3075				
					2 × 25				6,810	9,080	3,020	187	3100				
					3 × 25				7,560	10,300	3,450	234	3125				
					4 × 25				9,000	12,900	4,320	281	3150				
					5 × 25				10,300	15,500	5,180	327	3175				
					6 × 25				11,700	18,100	6,040	374	3200				
20	M5	4.3	8	4.2	—	40	5 ^{+0.012} ₀	2	7,110	7,920	2,640	255	4080				
					1 × 40				10,600	13,200	4,400	385	4120				
					2 × 40				13,800	18,400	6,160	510	4160				
					3 × 40				16,800	23,700	7,920	635	4200				
					4 × 40				19,700	29,000	9,680	770	4240				
					5 × 40				22,400	34,300	11,400	905	4280				

1N≐0.102kgf